

What does a pink box mean in the price list?

It contains essential information - make sure you read it!

August
2026



U value
1.38
W/m²K



U value
2.20
W/m²K



GARAGE DOOR RANGE PRICE LIST & TECHNICAL GUIDE

All prices exclude VAT and delivery

TECKENTRUP
DOOR SOLUTIONS

PRICE LIST AUGUST 2026

WHAT'S IN THIS PRICE LIST?

General Information	2
CarTeck Sectional Garage Doors	4
Matching Side Doors	4
CarTeck Garage Door Automation & Lighting	6
CarTeck SuperSize Sectional Garage Doors	7
CarTeck GSA Vision Sectional Garage Doors	8
CarTeck SLX Vision Sectional Garage Doors	9
CarTeck Side Hinged Garage Doors	10
Technical Information	13
Fitters Tips	17
Door Spares, Automation Spares, PVC Trim	20

PRICING

Prices are in £'s Sterling. This price list supersedes and renders null any previous price list.

TERMS

Comprehensive terms and conditions are on line at: www.teckentrup.co.uk/terms-conditions

DELIVERY

To company premises FOC.
To site £82 nett.

To the Scottish Highlands and Islands on application.
Congestion charges apply subject to postcode locations.

LEAD-TIMES

Lead times are subject to change and may be affected by the availability of raw materials, border delays and other factors beyond our control.

After placing your order you'll receive a confirmation with the week of delivery.

SIZES

When ordering use metric sizes, imperial conversions are nominal.











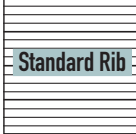





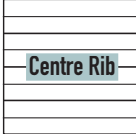



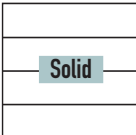

We work hard to maintain the advised delivery date and any slippage will be notified as soon as we become aware of an issue.

If you need a door for a specific date please call the sales office, we'll do our best to help.

BUILT FROM STOCK

The styles below are built from stock panels and available on a short lead time. Scan the QR codes to see the current lead times for all built from stock panel doors and other doors built from non-stock panels eg. other door styles, Trend, Trend+ and Trend Satin colours, RAL painted doors, Coastal painted, alternative surface finishes (Stucco, Micro-Profile, etc) and wood effect finishes.

SECTIONAL Built from stock panels in the finishes below:

							
							
							
		<p>**Available Georgian panel sizes Panel Size: Clear opening door width: 2246mm 2084mm - 2210mm 2476mm 2211mm - 2440mm 4608mm 4216mm - 4570mm</p>					



SECTIONAL LEAD TIMES

Built from stock panel doors & doors built from non-stock panels

SIDE HINGED Built from stock panels in the finishes below:



SIDE HINGED LEAD TIMES

Built from stock panel doors & doors built from non-stock panels

WHAT PERFORMANCE CAN I EXPECT?

As Part of the UKCA/CE marking process, each product must have its performance provided for a defined set of characteristics. Other characteristics can also be included if relevant to a door's performance, such as security. The following table shows the performance characteristics of each product in our range.

NPD signifies the product has not been measured for this characteristic (NPD - No Performance Determined)

PERFORMANCE CHARACTERISTIC	CarTeck Sectional Garage Doors	CarTeck SuperSize Sectional Garage Doors	CarTeck Sectional GSA Vision Garage Doors	CarTeck Sectional SLX Vision Garage Doors	CarTeck Side Hinged Garage Doors
Resistance to Windload EN 12424	Class 2	Class 2	Class 2	Class 2	Class 2
Watertightness EN 12425	Class 2	Class 2	Class 2	Class 2	NPD
Air Permeability EN 12426	Class 2	Class 2	Class 2	Class 2	NPD
Thermal Transmittance EN 13241	1.38 W/m ² k	1.29 W/m ² k	3.3 W/m ² k	3.5 W/m ² k	2.20 W/m ² k
Operating Forces (hand Operated) EN 12604	150 N	150 N	150 N	150 N	NPD
Operating Cycles EN 1191	NPD	NPD	NPD	NPD	NPD

WARRANTY

The warranty periods only apply to products that have been correctly installed as per the instructions and have been used, maintained by a Garage Door Specialist and cleaned in accordance with the requirements set out in the operating and maintenance sections of instructions and labels.

CARTECK, SUPERSIZE, GSA VISION & SLX VISION SECTIONAL GARAGE DOORS WARRANTY

2-year manufacturer's guarantee

- on polymer and aluminium window units

*5-year manufacturer's guarantee

- on SLX & GSA Vision windows, rollers, hinges, cable pulleys, cables and standard springs (opening/closing max. 5 times a day)

10-year manufacturer's guarantee

- on panels against rust penetration from inside to outside
- against door panel separation of steel from foam
- on material and manufacturing flaws of all non-moving parts of the frame that are verifiably unusable or whose usability is substantially compromised
- on floor seal, intermediate seals, side seals and lintel seal against rotting

The guarantee does not apply to doors that are subjected to extreme conditions, e.g. corrosive influences resulting from use in a coastal climate with high salt content.

***2-year for SuperSize**

CARTECK SIDE HINGED GARAGE DOORS WARRANTY

2-year manufacturer's guarantee

- on window units, hinges, locks, handles and stays (opening/closing max. 5 times a day)

10-year manufacturer's guarantee

- on panels against rust penetration from inside to outside
- against door panel separation of steel from foam
- on material and manufacturing flaws of all non-moving parts of the frame that are verifiably unusable or whose usability is substantially compromised
- on floor seal, intermediate seals and frame seals against rotting

The guarantee does not apply to doors that are subjected to extreme conditions, e.g. corrosive influences resulting from use in a coastal climate with high salt content.

CARTECK DRIVE & MOTOR WARRANTY

*5-year manufacturer's guarantee

- on mechanical defects, material and manufacturing flaws (opening/closing max. 5 times a day)**

*1-year for SuperSize

** Consumable Items are not included within warranty terms and conditions: hand transmitters, light bulbs, fuses & batteries.

CARTECK PAINT FINISH WARRANTY

5-year manufacturer's guarantee excluding coastal areas

- on peeling and blistering (normal colour fade excluded)

3-year manufacturer's guarantee for coastal locations on doors with the coastal paint upgrade

- on peeling and blistering (normal colour fade excluded) on the external face of the panels (not covering bleed from hardware)

HANDLING

CarTeck Sectional Doors are delivered flat-packed & CarTeck Side Hinged Doors are delivered complete (dependent on size). Both are heavy and require suitable consideration for safe handling.

CarTeck SuperSize and XL Sectional, CarTeck GSA Vision & CarTeck SLX Vision and sectional doors with wicket doors are delivered crated. Suitable arrangements for safe handling at delivery and onward transportation must be considered.

CLEANING ON INSTALLATION

After the installation has been completed, clean and dry the door thoroughly inside and out with warm soapy water to remove any grease, dust and metal fragments from the door (these will discolour the door finish if left on the door).

MAINTENANCE

Doors must be maintained as per the supplied Installation, Operating and Maintenance Manual by a Garage Door Specialist. Failure to carry out the required maintenance at the advised interval will invalidate the warranty.

CLEANING

The door should be washed with a car shampoo or similar, every two months, to prevent the build up of dirt, salt, grit and other corrosive substances. If the door is in an area prone to coastal corrosion from airborne salts, the door should be cleaned monthly. Furthermore, cleaning lifting gear with a cloth soaked in a light oil will help to protect your door from corrosion – it must be accepted that salt air is very aggressive and extra care is required.

No caustic, abrasive or corrosive chemicals and substances, flood water, water runoff, or runoff from lead, copper or galvanic metal flashing should be allowed to come into contact with the door. Contaminants can lead to oxidation spots on the external face of the door. Windows that have a mock lead effect may show a white residue due to oxidation over time, this should be removed should it contact painted surfaces.

Ash, cement, dust, animal waste, or foreign substances should be removed immediately. Do not apply excessive pressure when cleaning, doing so will affect the surface finish, leading to a permanent change in its lustre. Failure to ensure the door is cleaned and maintained as described will invalidate the doors' warranty.

For more information on what performance you can expect from your garage door, visit the Honesty Page on the Teckentrup website -

www.teckentrup.co.uk/garage-doors/the-honest-page



TECKENTRUP
DOOR SOLUTIONS ₃

CARTECK SECTIONAL GARAGE DOORS GSW 40-L

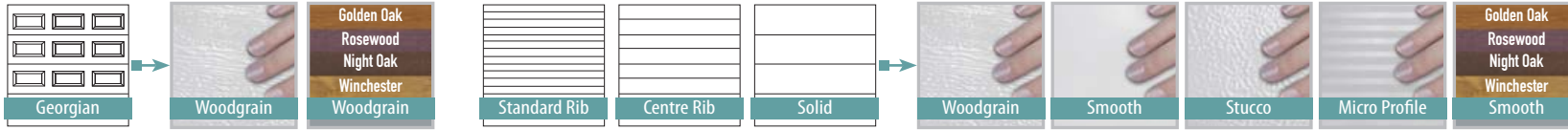

Preassembled spring trays
All single layer spring doors (120mm headroom) are supplied with preassembled spring trays for super-fast installation. Does not apply to double layer (140mm headroom doors) see page 12 for applicable sizes.

Georgian Features
Georgian design door widths of 2080mm and below have 2 features and come with an increased lead time - call the office for details.

Frame Legs, Headers & 3D Profiles

Frame legs/head - 85mm/115mm smooth & white as standard. For Trend, RAL or Wood Design, add the uplift to the white price.

Night Oak & Rosewood frame legs, headers & 3D profiles are finished in a complementary painted wood effect finish but will not match precisely.

Golden Oak & Winchester frame legs, headers & 3D profiles are finished in a flat colour RAL 8014. Golden Oak frame & header slip-over covers are available as an option - use the 3D cover price.

TT9016 Bling White frame legs, headers & 3D profiles are finished in RAL 9016.

All frame Legs, headers & 3D profiles are available in smooth finish only.

Between fix (No Holes) frames up to 2250mm high maximum (2135mm with 240mm headroom kit)

Below Ceiling Tracks

To order a door with tracks & spring trays that mount at ceiling level and that are above 240mm headroom, price the height for the opening + lintel height and advise the office when ordering.

Intermediate height or width or combination:
Next size + £192

Standard Heights

Sections	Standard Widths	Maximum Height mm	Standard Widths																				
			2084 6'10"	2134 7'0"	2235 7'4"	2286 7'6"	2388 7'10"	2438 8'0"	2591 8'6"	2743 9'0"	3048 10'0"	3353 11'0"	3658 12'0"	3962 13'0"	4216 13'10"	4267 14'0"	4420 14'6"	4572 15'0"	4877 16'0"	5182 17'0"	5500 18'0"		
4	1875 6'2"	2050 6'9"	2175 7'2"	White	1599	1599	1602	1602	1699	1699	1836	2001	2168	2332	2498	2662	2715	2771	2867	2888	3053	3216	3547
	1925 6'4"	2084 6'10"	2204 7'3"	Wood / Trend / Trend+	1756	1756	1773	1773	1874	1874	2013	2193	2370	2550	2727	2908	3082	3096	3167	3352	3533	3710	4070
	2000 6'6"	2125 7'0"	2250 7'4"	RAL	2116	2116	2128	2128	2252	2252	2424	2642	2858	3075	3291	3508	3725	3723	3815	4039	4254	4470	4903
5	2375 7'9"	2750 9'0"	White	1978	1978	2140	2140	2270	2270	2448	2668	2888	3107	3326	3546	3618	3691	3766	3845	4065	4283	4762	
	2500 8'2"	2625 8'9"	Wood / Trend / Trend+	2413	2413	2417	2417	2565	2565	2765	3012	3257	3506	3753	3999	4081	4164	4246	4334	4583	4829	5358	
	3000 9'9"	Need a door over 3000mm high? Call the office for a price - we can go up to 6000mm on our SuperSize lifting gear	RAL	2645	2645	2664	2664	2818	2818	3033	3304	3573	3845	4115	4385	4657	4653	4767	5046	5315	5585	6181	
6	2875 9'5"	3000 9'9"	White	2843	2843	2849	2849	3023	3023	3256	3548	3843	4133	4425	4719	4814	4911	5008	5110	-	-	-	
	Wood / Trend / Trend+	3206	3206	3211	3211	3413	3413	3672	4000	4329	4660	4988	5315	5425	5532	5639	5758	-	-	-			
	RAL	3590	3590	3609	3609	3796	3796	4049	4376	4700	5026	5351	5674	5999	6066	6131	6466	-	-	-			

FRAME LEG/HEADER COLOUR

Door price includes white frame legs and header. For colour matched frame legs & header add:

Please specify back fix frame or between fix (no holes) frame

White	0	0	0	0	0	0	0	0	0	0	0	0	0	0	0	0	0	0	0	0	0
Wood / Trend / Trend+	77	78	82	84	88	89	92	99	111	120	129	141	151	152	156	163	173	181	196		
RAL	335	340	347	354	360	364	378	393	419	445	468	494	518	523	535	550	560	576	630		

WINDOWS

Polymer Windows (type 1 Rectangle)

Number of windows	3	3	3	3	3	3	3	3	3	4	4	4	5	5	5	5	5	6	6	7
White	465	465	465	465	465	465	465	465	465	620	620	620	775	775	775	775	775	930	930	1085
Wood / Trend / Trend+	609	609	609	609	609	609	609	609	609	812	812	812	1015	1015	1015	1015	1015	1218	1218	1421

BETWEEN FIX ACCESSORIES

>3000mm 3D headers require a butt joint

	Width	<=3000mm	>3000mm
85mm Frame Leg 3D Profile Kit*	White	145	145
	Wood / Trend / Trend+	145	145
	RAL	239	239
85mm x 12mm x 3000mm 3D Legs			
85/120mm Frame 3D Profile Kit*	White	239	317
	Wood / Trend / Trend+	239	317
	RAL	379	504
85mm x 12mm x 3000mm 3D Legs			
120mm x 12mm x 3000mm 3D Header			
120mm Frame 3D Profile Kit*	White	263	347
	Wood / Trend / Trend+	285	379
	RAL	379	504
120mm x 12mm x 3000mm 3D Legs & 3D Header			
85mm 3D Frame Leg & Additional Door Header	White	284	383
	Wood / Trend / Trend+	308	414
	RAL	381	536
85mm x 12mm x 3000mm 3D Legs			
Additional Door Header to Width of Door			
120mm 3D Frame Leg & Additional Door Header	White	308	412
	Wood / Trend / Trend+	356	476
	RAL	438	616
120mm x 12mm x 3000mm 3D Legs			
Additional Door Header to Width of Door			
70mm Angle 3D Renovating Profile	White	263	347
	Wood / Trend / Trend+	285	379
	RAL	379	504
Kit 70mm x 12mm x 3000mm 3D Legs & 3D Header			

POPULAR ACCESSORIES/OPTIONS (For general options & spares see back page).

Manual locking black polymer handle & detent (factory prepared) 5000mm Max	£171 each
Manual locking black polymer handle & detent (onsite with template) 5000mm Max	£93 each
Brass handle upgrade add to manual locking price	NEW! £150 each
Stainless steel effect handle upgrade add to manual locking price	NEW! £150 each
Between reveal fitting kit - 10 brackets (Sideroom required 85mm)	£99 kit
Between reveal twist fix header bracket (2x) kit (Recommended for doors over 3000mm wide)	£38 kit
Horizontal track cut down charge	£192 per set
240mm headroom kit	£0
L shaped fixing strap kit	£30 pair
Sloping bottom panel (take largest height) add to door price	25%
Coastal paint upgrade (frame and external face of panels) add	£58 m ² to RAL price
Paint internal face of door panels to match exterior colour add	NEW! £150 m ² to RAL price
Floor seal kit length 2515mm/5030mm	£78/130

For door spares, motor spares & PVC finishing trims see back page.

SIDE DOORS

For more information and options, see CarTeck insulated side hinged doors page 10.

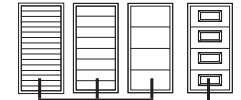

Maximum Over-Frame Size
Height up to 1250mm

Up to 2050 4 Section	White	1870	2059
	Wood/Trend/Trend+	2287	2477
	RAL	2553	2740
Up to 2204 4 Section	White	1964	2162
	Wood/Trend/Trend+	2380	2579
	RAL	2646	2845
Up to 2320 4 Section	White	2063	2269
	Wood/Trend/Trend+	2481	2686
	RAL	2746	2952
Up to 2500 5 Section	White	2063	2269
	Wood/Trend/Trend+	2481	2686
	RAL	2746	2952

*Golden Oak effect frame covers are available as an option to cover the standard frame supplied with a Golden Oak door, which is RAL 8014. Use the Wood 3D profile price. Golden Oak is available on the 3D kits marked with an *. Covers are supplied in standard lengths for cut down on site.

POLYMER WINDOWS

WINDOWS - POLYMER DOUBLE GLAZING Polymer casement with polymer (Styrene Acrylonitrile) double glazed unit.

Georgian



Rectangle 1 Plain Rectangle 1 Cross Mullion Rectangle 1 Rhombus

Standard Rib, Centre Rib & Solid



Rectangle 1 Plain Rectangle 1 Cross Mullion Rectangle 1 Rhombus Rectangle 2 Rectangle 3 Vertical Square 1 Vertical Square 2 GSA Aluminium

Style	Overall Size	Colour / Finish	Price
	Rectangle 1	White	£155 each
		Trend/Trend+/Ral/Wood design	£203 each
	Rectangle 2	White	£155 each
		Trend/Trend+/Ral/Wood design	£203 each
	Rectangle 3	White	£186 each
		Trend/Trend+/Ral/Wood design	£243 each
	Square 1 & 2	White	£155 each
		Trend/Trend+/Ral/Wood design	£203 each
	GSA Aluminium Window Section	White/Trend	£562 per m
		Trend+/Ral/Wood design	£844 per m

All polymer windows are available with these glazing options:

*The exterior pane is Frosted/Satin and the interior pane is Clear.



Polymer Windows

To price for windows fitted vertically down the door; square type 1 & 2, match windows to number of sections ie 4 sections = 4 windows).

Selected Trend colours & wood design windows are finished in a complementary flat colour for Golden Oak (RAL8003), Rosewood (RAL8016), Night Oak (RAL8014), Winchester (RAL8001), Textured Anthracite (RAL7016), Ice Crystal Grey Aluminium (RAL9007) and TT9016 Bling White (RAL9016).

The surrounds on aluminium GSA window sections are finished in a smooth finish. Window frame colour shade and surface lustre will show a variance from the panel finish as the base material and coating methods are different.

Polymer glazing in Georgian doors and Type 2 rectangle is 16mm thick. All other polymer glazing is 20mm thick.

ALUMINIUM WINDOWS & DECALS

ALUMINIUM WINDOWS - POLYMER DOUBLE GLAZING Aluminium and polymer casement with polymer double glazed unit.

PRICE PER WINDOW

£382



Alpha
280mm x 280mm



Sigma
610mm x 200mm

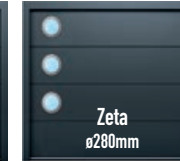

Zeta
ø280mm



Gamma
534mm x 344mm

PRICE PER SET

£914



Kappa
1860mm x 180mm



Athena
406mm x 203mm

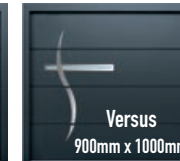

Versus
900mm x 1000mm

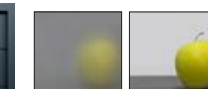

Satin Clear
All aluminium windows are available with these glazing options (satin is supplied as standard).

ALUNOX DECALS

Factory bonded alunox decals. Decals can be positioned to requested positions, however, popular arrangements are shown here.

PRICE PER DECAL

£67

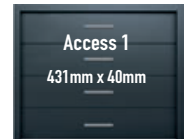

Access 1
431mm x 40mm

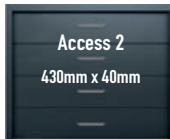

Access 2
430mm x 40mm



Access 3
215mm x 40mm



Access 4
400mm x 86mm

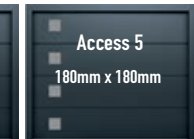

Access 5
180mm x 180mm

PRICE PER DECAL

£67

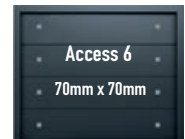

Access 6
70mm x 70mm

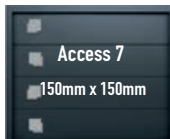

Access 7
150mm x 150mm

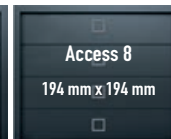

Access 8
194mm x 194mm



Access 9
436mm x 40mm



Access 10
431mm x 13mm

PRICE PER DECAL

100mm £61

200mm £67

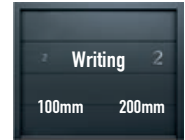

Writing
100mm 200mm

EXTRA TOUCHES

PET FLAP

£52 fitting charge*
*Customer supplied



SPY HOLE

£61



LETTER BOX

£130*
*£52 fitting charge if Customer supplied



Letter boxes are available finished in Satin Nickel as standard with an option for Gold, Rose Gold, Chrome, Black, White or Anthracite.

TREND COLOURS



TREND+ COLOURS



TREND SATIN COLOURS



ADD £41 m² to Trend price

COASTAL UPGRADE

Doors installed in coastal/high salinity environments must have the coastal paint upgrade. The upgraded paint is applied to the frame and external face of panels and comes with a three year warranty, subject to terms and conditions, on peeling and blistering (normal colour fade excluded) on the external face of the panels (not covering bleed from hardware).



ADD £58 m² to RAL price

Colours

Where doors are exposed to direct sunlight, dark colours should be avoided. RAL/BS references for colours are provided as a guide only to the nearest similar RAL/BS colour. Colours will not match to other RAL/BS finishes due to different coating processes, gloss levels, substrates and textures. Similarly, special RAL, BS, wood effects or other colours will not be a precise match.

Colours shown are limited in accuracy by the printing process - samples should always be requested.

If you are matching to other finishes, particularly wood effects such as rosewood, golden oak, night oak or Winchester, always request a sample.

CARTECK DRIVE



Drive 500 / 600



Drive Pro 500 / 600

Drives require 140mm headroom. To fit within 120mm use the Spacer Bar Suspension Plate that lowers the rear spacer bar by 40 mm

Motor	Price	Included accessories	
Drive 500Nm	£463	2 x Pearl Twin transmitters	180mm/sec
Drive 600Nm	£526	2 x Pearl transmitters	▶▶▶
Drive Pro 500Nm	£504	2 x Pearl Twin transmitters	240mm/sec
Drive Pro 600Nm	£555	2 x Pearl transmitters	▶▶▶▶

Rail extension 1096mm (heights greater than 2375mm)	add	£127
Spacer bar suspension plate (for 120mm headroom)		£39
Rear mount arm (allows rail to be shortened & the rail insertion depth reduced by up to 240mm)		£103

CARTECK DRIVE ACCESSORIES

Post & packing may apply to accessories not ordered with a door

Description	Price	Compatibility	
		500	600
2-function handheld transmitter „Pearl Twin“	£84	•	•
4-function handheld transmitter „Pearl“	£98	•	•
3-function handheld transmitter „Pearl status“	£127	•	•
4-function handheld transmitter „Pearl vibe“	£178	•	•
Holding clip for pearl transmitter for sun shield	£18	•	•
Holder Pearl for mounting pearl transmitter white or black	£25	•	•
868 MHz Radio receiver (2-channel)	£178	•	•
Access Pack 1: Keypad (without Courier function)	£290	•	•
Access Pack 2: wireless 2 function wall switch white or grey	£127	•	•
Access Pack 3: Surface mounted keypad	£494	•	•
Access Pack 4: Keypad with Courier function, includes safety pack 1	£306	•	•
Wired 3 function internal wall station	£63	•	•
Safety Pack 1 Photo cell kit (Includes mounting kit if required)	£162	•	•
Additional light strip attaches to control unit	£69	•	•
Ambience pack 1: light strip & motion sensor	£137	•	•
Ambience pack 2: relay to control lighting	£47	•	•
Parking Pack 1: position laser & reflector	£105	•	•
Parking Pack 2: humidity sensor (1hr as standard) (60kg of resistance)	£41	•	•
Security pack 1: lock & alarm buzzer (300kg of resistance)	£110	•	•
Security pack 2: alarm buzzer & lighting control relay	£143	•	•
Power pack: battery backup	£255	•	•
Smart pack: output module for smart home integration <small>Third party equipment may be required.</small>	£178	•	•
External release for garages without a second entrance	£67	•	•
Special 101 towing arm bracket	£142	•	•
SOMlink Engineer Tool	£160	•	•

CARTECK MOTOR

NEW!

CarTeck MOTOR L60 Belt Drive



160mm/sec



Doors up to 123kg
(see page 13 for door sizes)

CarTeck MOTOR L75 Belt Drive



200mm/sec



All doors

CarTeck MOTOR

Motor Head	Price	Included accessories
L60	£436	2 x 4-channel transmitters
L75	£490	2 x 4-channel transmitters 1 x wireless wall switch

One-piece rail in place of standard 2-piece rail add	£26
Doors over 2500mm high require rail extension add	£21
Extra twist fix rail bracket each	£43
Extra hanging bracket each	£46

CARTECK MOTOR ACCESSORIES

NEW!

Post & packing may apply to accessories not ordered with a door

Transmitter 4 channel	£63	Photocells	£94
myQ Gateway with photocells	£219	Wireless digital key pad	£146
myQ LED Radio Light <small>Activated by transmitter 1500 lumen and 4000K light 1800mm power lead</small>	£208	Wireless 2-channel wall control	£65
		External release for garages without a second entrance	£67
		Special 101 towing arm bracket	£142

Featured Accessories



1500 lumen/m neutral white 4000K light.

Ambience Pack 3 LED strips for tracks and spacer bar Price Compatibility 500 600

3rd generation ambience pack 3: 2 x threads (left/right) 2m and 1m of LED lights, motion sensor & remote control

£331 • •

Ambience Pack 4 Price 500 600

Light bars with stand-alone power supply and motion detector

Width up to 2220mm £412 • •

Width up to 3205mm £531 • •

Width up to 4190mm £548 • •

Width up to 5528mm £796 • •

Link to Amazon Alexa - Smart Home* £125 • •

*Only compatible with Ambience pack 4. Third party equipment may be required.

SOMweb Smart Phone Module with Safety Photo Cells

Allows control of up to 10 doors £514 • •

SOMweb is required to interface with smart home systems such as Google Home, Apple Homekit and Amazon Alexa (does not require additional 3rd party equipment)



For door spares, motor spares & PVC finishing trims see back page.

XL SECTIONAL GARAGE DOORS & SUPERSIZE SECTIONAL GARAGE DOORS

NEW! XL sectional garage doors extend the available width of GSW 40L doors up to 6250mm. XL doors have a rear-mount torsion springs, X pack roller brackets and panel reinforcing profiles. XL doors can be fitted behind and between the reveal and are available with a colour matched frame and header in all designs.

SuperSize sectional garage doors are available from 6000mm to 8000mm. SuperSize doors have industrial roller brackets, panel reinforcing profiles and front-mount torsion springs with the option of low-headroom rear-mount torsion springs. They have a galvanized frame and no header. SuperSize doors can be fitted behind the reveal only and are available in Standard Rib, Centre Rib and Solid designs only.

XL sectional garage doors



XL & SuperSize sectional garage doors

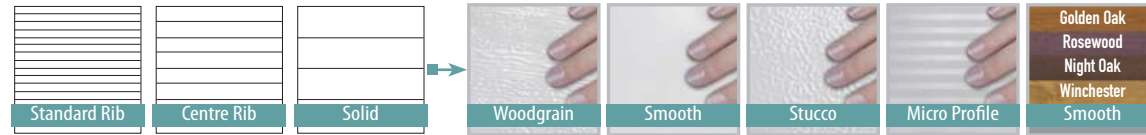

XL SECTIONAL GARAGE DOORS

Pricing includes Motor: CarTeck DRIVE Pro 1100 rail operator & 2 transmitters

Intermediate height or width or combination: Next size + £192

XL widths start at 5501mm
*Max height on 6250mm width on 5 section doors = 2375mm

Standard Heights

Sections	Standard Widths up to	Maximum Height mm	White	Trend/Wood	RAL
4	1875 6'2"	2050 6'9"	2175 7'2"	5500	5702
	1925 6'4"	2084 6'10"	2204 7'3"	5500	5702
	2000 6'6"	2125 7'0"	2250 7'4"	6222	6455
	Max 4 section height 2280			6455	6736
5	2375 7'9"		6376	6634	6692
	2500 8'2"		6376	6634	6692
			7167	7459	7535

FRAME LEG/HEADER COLOUR

Door price includes white frame legs and header. For colour matched frame legs & header add: Back fix frame only, not available with between fix (no holes) frame

White	0	0	0	0
Wood/Trend	196	206	216	226
RAL	630	645	655	665

WINDOWS

Polymer Windows (type 1 Rectangle)	White	1085	1240	-	-
	Wood/Trend/RAL	1421	1624	-	-

TREND COLOURS



Colours
Where doors are exposed to direct sunlight, dark colours should be avoided. RAL references for colours are provided as a guide only to the nearest similar RAL colour. Colours will not match to other RAL finishes due to different coating processes, gloss levels, substrates and textures. Similarly, special RAL, BS, wood effects or other colours will not be a precise match. Colours shown are limited in accuracy by the printing process - samples should always be requested. If you are matching to other finishes, particularly wood effects such as rosewood, golden oak, night oak or Winchester, always request a sample.

SUPERSIZE SECTIONAL GARAGE DOORS

Pricing includes Motor: CarTeck DRIVE Pro 1100 rail operator or Teckentrup Direct Drive, optical safety edge, photocells, 2 transmitters & 1 pair of tension bars

Heights up to:

Sections	Heights up to:	Motor	White/Wood/Trend RAL	6000	6500	7000	7500	8000
4	2280	Rail Operator	White/Wood/Trend RAL	7276	8486	-	-	-
		Direct Drive	White/Wood/Trend RAL	8033	9307	-	-	-
5	2835	Direct Drive	White/Wood/Trend RAL	8170	9293	10454	10920	11395
			RAL	8928	10113	11336	11867	12402
6	3000	Direct Drive	White/Wood/Trend RAL	9159	10643	12087	12671	13256
			RAL	10166	11736	13265	13933	14601
Polymer Windows (type 1 Rectangle)			White	1240	-	-	-	-
			Trend/Wood/RAL	1624	-	-	-	-

POLYMER WINDOWS

WINDOWS - POLYMER DOUBLE GLAZING Polymer casement with polymer (Styrene Acrylonitrile) double glazed unit.

Style	Overall Size	Colour / Finish	Price
Rectangle 1	610 X 270	White	£155 each
		Trend/Ral/Wood design	£203 each
Rectangle 2	680 X 210	White	£155 each
		Trend/Ral/Wood design	£203 each
Rectangle 3	980 X 140	White	£186 each
		Trend/Ral/Wood design	£243 each
Square 1 & 2	270 x 270	White	£155 each
		Trend/Ral/Wood design	£203 each
GSA Aluminium Window Section	per linear m	White/Trend	£562 per m
		Ral/Wood design	£844 per m

All polymer windows are available with these glazing options:

*The exterior pane is Frosted/Satin and the interior pane is Clear.

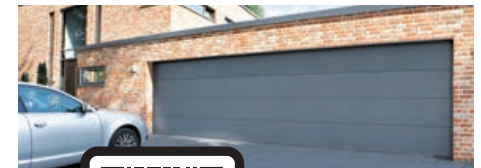

What are XL & SuperSize garage doors?

SCAN ME!

SUPERSIZE OPTIONS	
Rail Drive - Low Headroom up to 6500mm	£ 446
Direct Drive - Low Headroom 6501mm - 7750mm	£ 614



Teckentrup Direct Drive motors must have 13 amp supply direct to the consumer unit.

Polymer Windows
To price for windows fitted vertically down the door, square type 1 & 2, match windows to number of sections ie 4 sections = 4 windows). Selected Trend colours & wood design windows are finished in a complementary flat colour for Golden Oak (RAL8003), Rosewood (RAL8016), Night Oak (RAL8014), Winchester (RAL8001), Textured Anthracite (RAL7016), Ice Crystal Grey Aluminium (RAL9007) and TT9016 Bling White (RAL9016). The surrounds on aluminium GSA window sections are finished in a smooth finish. Window frame colour shade and surface lustre will show a variance from the panel finish as the base material and coating methods are different. Polymer glazing in Type 2 rectangle is 16mm thick. All other polymer glazing is 20mm thick.

CARTECK SECTIONAL GARAGE DOORS GSA VISION



GSA Vision Options

Sectional door panels made from hollow aluminium profiles, 40mm profile depth with 20mm scratch resistant, polymer double glazing.

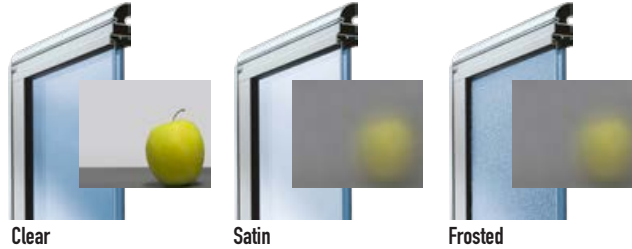

MATCHING SIDE DOORS



GSA Vision double leaf doors are available - double the prices right.

Maximum Over-Frame Size Height / Width*	Single leaf Up to 1250	
	Up to 2050 4 Section	Trend RAL
Up to 2204 4 Section	Trend RAL	5399 5671
Up to 2320 5 Section*	Trend RAL	5502 5771

Doors are prepared for automation as standard (manual locking not available)

Heights up to:

Sections	Height	White/Trend RAL	Widths up to:																			
			2084 6'10"	2134 7'0"	2235 7'4"	2286 7'6"	2388 7'10"	2438 8'0"	2591 8'6"	2743 9'0"	3048 10'0"	3353 11'0"	3658 12'0"	3962 13'0"	4216 13'10"	4267 14'0"	4420 14'6"	4572 15'0"	4877 16'0"	5182 17'0"	5500 18'0"	
4	2280		3000	3000	3000	3000	3000	3000	3000	3000	3000	3000	3000	3000	3000	3000	3000	2875	2625	2500	2500	
5	2835		6062	6062	6062	6153	6237	6754	6754	6767	7127	7335	7867	8052	8228	8415	8415	8936	9382	9570	9745	
6	3000		7176	7176	7176	7278	7377	7377	8019	8031	8436	8662	9316	9510	9713	9916	10559	10572	11035	11238	11424	
			7403	7403	7403	7518	7620	8267	8267	8278	8727	8946	9607	9837	10341	10572	10572	11222	11451	11681	11901	
			8800	8800	8800	8924	9048	9048	9849	9861	10363	10602	11419	11659	12196	12449	13250	13266	13514	13768	13998	
			8699	8699	8699	8834	8959	9737	9737	9745	10280	10839	11631	11904	12162	12436	12436	13216	13486	-	-	
			10372	10372	10372	10524	10671	10671	11634	11642	12243	12831	13804	14092	14390	14694	15652	15667	15966	-	-	
			Number of windows																			
			2	2	2	3	3	3	4	4	4	4	5	5	5	5	5	6	6	6	6	
			2250mm			2500mm			3500mm				4500mm				5500mm					

FRAME LEG/HEADER COLOUR

Door price includes white frame legs and header. For colour matched frame legs & header add: Please specify back fix frame or between fix (no holes) frame

Colour	0	0	0	0	0	0	0	0	0	0	0	0	0	0	0	0	0	0	0	0
White	0	0	0	0	0	0	0	0	0	0	0	0	0	0	0	0	0	0	0	0
Trend	77	78	82	84	88	89	92	99	111	120	129	141	151	152	156	163	173	181	196	196
RAL	335	340	347	354	360	364	378	393	419	445	468	494	518	523	535	550	560	576	630	630

Frame Legs, Headers & 3D Profiles

Frame legs/head - 85mm/115mm smooth & white as standard.

All frame Legs, headers & 3D profiles are available in smooth finish only.

Between fix (No Holes) frames up to 2250mm high maximum (2135mm with 240mm headroom kit.)

BETWEEN FIX ACCESSORIES

>3000mm 3D headers require a butt joint

Accessory	Width	<=3000mm >3000mm	
		<=3000mm	>3000mm
85mm Frame Leg 3D Profile Kit*	White	145	145
85mm x 12mm x 3000mm 3D Legs	Trend	145	145
	RAL	239	239
85/120mm Frame 3D Profile Kit*	White	239	317
85mm x 12mm x 3000mm 3D Legs 120mm x 12mm x 3000mm 3D Header	Trend	239	317
	RAL	379	504
120mm Frame 3D Profile Kit*	White	263	347
120mm x 12mm x 3000mm 3D Legs & 3D Header	Trend	285	379
	RAL	379	504
85mm 3D Frame Leg & Additional Door Header	White	284	383
85mm x 12mm x 3000mm 3D Legs Additional Door Header to Width of Door	Trend	308	414
	RAL	381	536
120mm 3D Frame Leg & Additional Door Header	White	308	412
120mm x 12mm x 3000mm 3D Legs Additional Door Header to Width of Door	Trend	356	476
	RAL	438	616
70mm Angle 3D Renovating Profile	White	263	347
Kit 70mm x 12mm x 3000mm 3D Legs & 3D Header	Trend	285	379
	RAL	379	504

TREND COLOURS

NOTE: Flat colours only

White RAL 9016	White Aluminium RAL 9006	Grey Aluminium RAL 9007	Light Grey RAL 7035
Window Grey RAL 7040	Quartz Grey RAL 7039	Umbra Grey RAL 7022	Slate Grey RAL 7015
Anthracite Grey RAL 7016	Jet Black RAL 9005	Steel Blue RAL 5011	Moss Green RAL 6005
Fir Green RAL 6009	Flame Red RAL 3000	Sepia Brown RAL 8014	Cream RAL 9001

Colours

Where doors are exposed to direct sunlight, dark colours should be avoided.

RAL references for colours are provided as a guide only to the nearest similar RAL colour. Colours will not match to other RAL finishes due to different coating processes, gloss levels, substrates and textures. Similarly, special RAL, BS or other colours will not be a precise match.

Colours shown are limited in accuracy by the printing process - samples should always be requested.

POPULAR ACCESSORIES/OPTIONS

Between reveal fitting kit -10 brackets (Sideroom required 85mm)	£99 kit	
Between reveal twist fix header bracket (2x) kit (Recommended for doors over 3000mm wide)	£38 kit	
Horizontal track cut down charge	£192 per set	
240mm headroom kit	£0	
L shaped fixing strap kit	£30 pair	
Floor seal kit length 2515mm/5030mm	£ 78/130	

For door spares & motor spares see back page.

CARTECK SECTIONAL GARAGE DOORS SLX VISION



Full width glazing up to 3000mm wide (no mullions)



Single mullion over 3000mm wide

Doors are prepared for automation as standard (manual locking not available)

Heights up to:

		Widths up to:	2084	2134	2235	2286	2388	2438	2591	2743	3048	3353	3658	3962	4000
		Maximum Height mm	3000	3000	3000	3000	3000	3000	3000	3000	3000	3000	3000	3000	3000
4 Sections	2280	White/Trend	6062	6062	6062	6153	6237	6754	6754	6767	7127	7335	7867	8052	8228
		RAL	7176	7176	7176	7278	7377	7377	8019	8031	8436	8662	9316	9510	9713
5 Sections	2835	White/Trend	7403	7403	7403	7518	7620	8267	8267	8278	8727	8946	9607	9837	10341
		RAL	8800	8800	8800	8924	9048	9048	9849	9861	10363	10602	11419	11659	12196
6 Sections	3000	White/Trend	8699	8699	8699	8834	8959	9737	9737	9745	10280	10839	11631	11904	12162
		RAL	10372	10372	10372	10524	10671	10671	11634	11642	12243	12831	13804	14092	14390
		Number of windows	1	1	1	1	1	1	1	1	1	2	2	2	2

3000mm

FRAME LEG/HEADER COLOUR	White	0	0	0	0	0	0	0	0	0	0	0	0	0	0
Door price includes white frame legs and header.	Trend	77	78	82	84	88	89	92	99	111	120	129	141	151	
For colour matched frame legs & header add:	RAL	335	340	347	354	360	364	378	393	419	445	468	494	518	
Please specify back fix frame or between fix (no holes) frame															

BETWEEN FIX ACCESSORIES

>3000mm 3D headers require a butt joint

	Width	<=3000mm	>3000mm
85mm Frame Leg 3D Profile Kit*	White	145	145
85mm x 12mm x 3000mm 3D Legs	Trend	145	145
	RAL	239	239
85/120mm Frame 3D Profile Kit*	White	239	317
85mm x 12mm x 3000mm 3D Legs 120mm x 12mm x 3000mm 3D Header	Trend	239	317
	RAL	379	504
120mm Frame 3D Profile Kit*	White	263	347
120mm x 12mm x 3000mm 3D Legs & 3D Header	Trend	285	379
	RAL	379	504
85mm 3D Frame Leg & Additional Door Header	White	284	383
85mm x 12mm x 3000mm 3D Legs Additional Door Header to Width of Door	Trend	308	414
	RAL	381	536
120mm 3D Frame Leg & Additional Door Header	White	308	412
120mm x 12mm x 3000mm 3D Legs Additional Door Header to Width of Door	Trend	356	476
	RAL	438	616
70mm Angle 3D Renovating Profile	White	263	347
Kit 70mm x 12mm x 3000mm 3D Legs & 3D Header	Trend	285	379
	RAL	379	504

TREND COLOURS

NOTE: Flat colours only

Colours			
White RAL 9016	White Aluminium RAL 9006	Grey Aluminium RAL 9007	Light Grey RAL 7035
Window Grey RAL 7040	Quartz Grey RAL 7039	Umbra Grey RAL 7022	Slate Grey RAL 7015
Anthracite Grey RAL 7016	Jet Black RAL 9005	Steel Blue RAL 5011	Moss Green RAL 6005
Fir Green RAL 6009	Flame Red RAL 3000	Sepia Brown RAL 8014	Cream RAL 9001

Where doors are exposed to direct sunlight, dark colours should be avoided. RAL references for colours are provided as a guide only to the nearest similar RAL colour. Colours will not match to other RAL finishes due to different coating processes, gloss levels, substrates and textures. Similarly, special RAL, BS or other colours will not be a precise match. Colours shown are limited in accuracy by the printing process - samples should always be requested.

VISION OPTIONS

Sectional door panels made from hollow aluminium profiles, 40mm profile depth with 20mm scratch resistant, polymer double glazing.

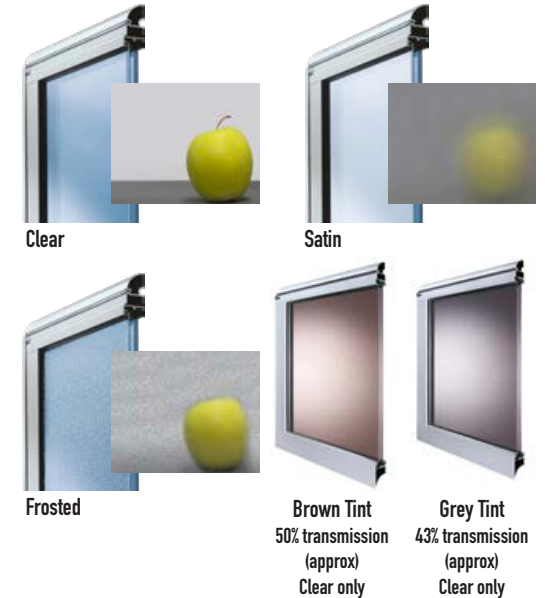

Frame Legs, Headers & 3D Profiles

Frame legs/head - 85mm/115mm smooth & white as standard. All frame Legs, headers & 3D profiles are available in smooth finish only. Between fix (No Holes) frames up to 2250mm high maximum (2135mm with 240mm headroom kit.)

POPULAR ACCESSORIES/OPTIONS

Between reveal fitting kit -10 brackets (Sideroom required 85mm)	£99 kit
Between reveal twist fix header bracket (2x) kit (Recommended for doors over 3000mm wide)	£38 kit
Horizontal track cut down charge	£192 per set
240mm headroom kit	£0
L shaped fixing strap kit	£30 pair
Floor seal kit length 2515mm/5030mm	£ 78/130

For door spares & motor spares see back page.

RIBBED & GEORGIAN DESIGN CARTECK SIDE HINGED GARAGE DOORS GSW 40-L

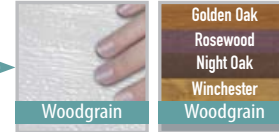
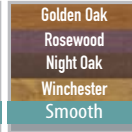
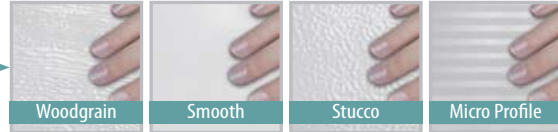

Available split 1/2 - 1/2 or asymmetric (1524mm maximum leaf width for asymmetric up 3188 wide, 1684 over 3188)



Minimum leaf-width for single or double leaf doors that require a stay: 810mm. Minimum leaf width without a stay: 500mm

Minimum leaf-width for single or double leaf doors that require a stay: 824mm. Minimum leaf width without a stay: 824mm.



Minimum overframe size on vertical single doors is 940mm
Minimum overframe size on horizontal single doors is 950mm
Minimum overframe size for vertical double doors is 1760mm
Minimum overframe size for horizontal double doors is 1790mm

Available split 1/2 - 1/2 or asymmetric (1524mm maximum leaf width for asymmetric up 3188 wide, 1684 over 3188)

Maximum Over-Frame Size		RIBBED DESIGN DOUBLE LEAF							
		*Doors over 3188mm wide are supplied with surface mounted hinges (not concealed) and as a loose frame and door leaves for assembly on site							
Height	Width up to:	1250	2286	2438	2500	2750	3000	3188	3500*
Up to 2050 4 Section	White	1870	2681	2801	2934	3220	3548	3662	4162
	Wood/Trend Trend+	2287	3132	3256	3388	3672	4000	4116	4613
	RAL	2553	3437	3560	3689	3974	4304	4417	4919
Up to 2204 4 Section	White	1964	2801	2929	3073	3543	3903	4028	4732
	Wood/Trend Trend+	2380	3256	3383	3526	3811	4141	4254	4963
	RAL	2646	3560	3685	3828	4114	4486	4556	5144
Up to 2320 4 Section Up to 2500 5 Section	White	2063	2934	3073	3268	3762	4098	4225	4859
	Wood/Trend Trend+	2481	3388	3526	3723	4009	4336	4451	5120
	RAL	2746	3689	3828	4023	4309	4638	4751	5252

Maximum Over-Frame Size		GEORGIAN DESIGN DOUBLE LEAF							
		*Doors over 3188mm wide are supplied with surface mounted hinges (not concealed) and as a loose frame and door leaves for assembly on site							
Height	Width up to:	1250	2286	2438	2500	2750	3000	3188	3500*
Up to 2050 4 Section	White	2059	2929	3065	3207	3493	3820	3935	4434
	Wood/Trend Trend+	2477	3383	3520	3661	3946	4275	4389	4888
	RAL	2740	3685	3822	3965	4250	4579	4693	5192
Up to 2204 4 Section	White	2162	3065	3207	3359	3644	3972	4098	4586
	Wood/Trend Trend+	2579	3520	3661	3810	4096	4425	4538	5039
	RAL	2845	3822	3965	4115	4399	4724	4839	5334
Up to 2320 4 Section Up to 2500 5 Section	White	2269	3207	3359	3516	3802	4129	4244	4743
	Wood/Trend Trend+	2686	3661	3810	3970	4256	4584	4698	5197
	RAL	2952	3965	4115	4273	4559	4887	5001	5502

Note: if there is an obstruction that prevents the full opening of a door leaf we can limit the travel of the door stay/s to prevent a clash – talk to the team!

Frames & Door Leaf Frames

Frames and door leaf frames in selected Trend colours & wood design are finished in a complementary flat colour:
Golden Oak (RAL8003), Rosewood (RAL8016), Night Oak (RAL8014), Winchester (RAL8001), Ice Crystal Grey Aluminium (RAL9007), TT9016 Bling White (RAL9016).

Frames and door leaf frames are available in smooth finish only (excluding textured anthracite).

Prices are for a single colour to all components of the door. If you require a different colour for the frame to the door panel a surcharge will apply – please contact the office for details. As a guide, a different frame colour is charged at £150 for any size of door.

Door Restrictor

A door restrictor is available on door leaves below 810mm width down to minimum leaf width 500mm – see technical specification for more detail. Must be requested when ordering.

Open-Out / Open-In

Doors are supplied open-out as standard. Open-in is available as an option – please specify when ordering. NOTE: open-in doors increase the likelihood of water ingress. A drip guard is recommended on open-in doors

***Doors Over 3188mm**

Doors over 3188mm wide are supplied with surface mounted hinges (not concealed) and as a loose frame and door leaves for assembly on site.

Threshold

All* doors include a 3-part raised aluminium threshold for improved weather protection. *Doors over 3000mm wide are supplied with the 1-piece threshold.

Colours

Where doors are exposed to direct sunlight, dark colours should be avoided.

RAL/BS references for colours are provided as a guide only to the nearest similar RAL/BS colour. Colours will not match to other RAL/BS finishes due to different coating processes, gloss levels, substrates and textures. Similarly, special RAL, BS, wood effects or other colours will not be a precise match. *RAL9006 and 9007 pose particular problems when colour matching, more information is available via the sales office. Colours shown are limited in accuracy by the printing process – samples should always be requested.

If you are matching to other finishes, particularly wood effects such as Rosewood, Golden Oak, Night Oak or Winchester, always request a sample.



TREND COLOURS

TT9016 Bling White with miscellaneous iron particles glitter effect	Ice Crystal Grey Aluminium	White Aluminium RAL 9006	Grey Aluminium RAL 9007	Light Grey RAL 7065
Window Grey RAL 7040	Quartz Grey RAL 7039	Umber Grey RAL 7022	Slate Grey RAL 7015	Anthracite Grey RAL 7016
Anthracite Textured RAL 7016	TT 703 A special satin metallic effect (grey with microscopic iron ore particles)	Jet Black RAL 9005	Steel Blue RAL 5011	Moss Green RAL 6005
Fir Green RAL 6009	Flame Red RAL 3000	Sage Brown RAL 8014	Cream RAL 9001	

TREND+ COLOURS

Agate Grey RAL 7038	Silver Grey RAL 7001	Pebble Grey RAL 7032	Stone Grey RAL 7030	Mousse Grey RAL 7005
Basalt Grey RAL 7012	Graphite Grey RAL 7024	Granite Grey RAL 7026	Graphite Black RAL 9011	Signal Black RAL 9004
Genial Blue RAL 5010	Pigeon Blue RAL 5014	Chartwell Green BS 14 C 35	Sage Green RAL 130 60 10	Burgundy RAL 3004
Ruby Red RAL 3003	Terra Brown RAL 8028	Nut Brown RAL 8011	Light Ivory RAL 1015	Pure White RAL 9010

TREND SATIN COLOURS

White RAL 9016	Jet Black RAL 9005	Anthracite Grey RAL 7016	Trend Satin Colours have a 10% gloss level (hence the name "Satin") compared to the 30% gloss level of Trend and Trend+ colours
Agate Grey RAL 7038	Chartwell Green BS 14 C 35	Pebble Grey RAL 7032	

ADD £41 m² to Trend price

COASTAL PAINT UPGRADE

Doors installed in coastal/high salinity environments must have the coastal paint upgrade. The upgraded paint is applied to the frame, leaf capping and external face of panels and comes with a three year warranty, subject to terms and conditions, on peeling and blistering (normal colour fade excluded) on the external face of the panels (not covering bleed from hardware).

ADD £58 m² to RAL price



TOPLIGHT & TRADITIONAL DESIGN CARTECK SIDE HINGED GARAGE DOORS GSW 40-L

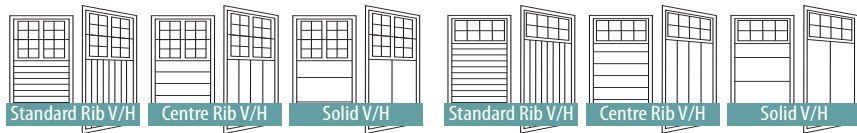

Minimum single leaf over frame size: 650mm. Minimum double leaf over frame size: 1180mm. 50/50 Split only. Asymmetric POA (1524mm maximum leaf width for asymmetric up 3188 wide, 1684 over 3188).



Minimum leaf-width for single or double leaf doors that require a stay: 810mm. Minimum leaf width without a stay: 500mm

Available split 1/2 - 1/2 or asymmetric (1524mm maximum leaf width for asymmetric up 3188 wide, 1684 over 3188)

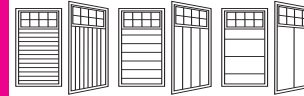

Minimum leaf-width for single or double leaf doors that require a stay: 810mm. Minimum leaf width without a stay: 500mm

TREND COLOURS

TT9016 Bling White RAL 7016 <small>with micaceous iron ore particles glitter effect</small>	Ice Crystal Grey Aluminium RAL 7035	White Aluminium RAL 9006	Grey Aluminium RAL 9007	Light Grey RAL 7055
Window Grey RAL 7040	Quartz Grey RAL 7039	Umber Grey RAL 7022	Slate Grey RAL 7015	Anthracite Grey RAL 7016
Anthracite Textured RAL 7016	TT 703 <small>A special satin metallic effect (grey with micaceous iron ore particles)</small>	Jet Black RAL 9005	Steel Blue RAL 5011	Moss Green RAL 6005
Fir Green RAL 6009	Flame Red RAL 3000	Sepia Brown RAL 8014	Cream RAL 9001	

TREND+ COLOURS

Agate Grey RAL 7038	Silver Grey RAL 7001	Pebble Grey RAL 7032	Stone Grey RAL 7030	Mousse Grey RAL 7005
Basalt Grey RAL 7012	Graphite Grey RAL 7024	Granite Grey RAL 7026	Graphite Black RAL 9011	Signal Black RAL 9004
Gentian Blue RAL 5010	Pigeon Blue RAL 5014	Chartwell Green BS 14 C 35	Sage Green RAL 130 60 10	Burgundy RAL 3004
Ruby Red RAL 3003	Terra Brown RAL 8028	Nat Brown RAL 8011	Light Ivory RAL 1015	Pure White RAL 9010

TREND SATIN COLOURS

White RAL 9016	Jet Black RAL 9005	Anthracite Grey RAL 7016	Trend Satin Colours have a 10% gloss level (hence the name "Satin") compared to the 30% gloss level of Trend and Trend+ colours
Agate Grey RAL 7038	Chartwell Green BS 14 C 35	Pebble Grey RAL 7032	

ADD £41 m² to Trend price

COASTAL PAINT UPGRADE

Doors installed in coastal/high salinity environments must have the coastal paint upgrade. The upgraded paint is applied to the frame, leaf capping and external face of panels and comes with a three year warranty, subject to terms and conditions, on peeling and blistering (normal colour fade excluded) on the external face of the panels (not covering bleed from hardware).

ADD £58 m² to RAL price



Maximum Over-Frame Size

Height	Width up to:	TOPLIGHT DESIGN DOUBLE LEAF							
		1250	2286	2438	2500	2750	3000	3188	3500*
Up to 2050 4 Section	White	2141	3221	3342	3475	3761	4089	4474	4973
	Wood/Trend Trend+	2558	3673	3796	3929	4212	4541	4927	5424
	RAL	2823	3977	4101	4230	4515	4845	5229	5730
Up to 2204 4 Section	White	2234	3342	3470	3613	4084	4443	4840	5544
	Wood/Trend Trend+	2650	3796	3923	4067	4352	4682	5065	5775
	RAL	2917	4101	4226	4368	4654	5027	5367	5956
Up to 2320 4 Section Up to 2500 5 Section	White	2333	3475	3613	3809	4095	4423	4807	5307
	Wood/Trend Trend+	2751	3929	4067	4263	4549	4877	5262	5932
	RAL	3016	4230	4368	4564	4850	5179	5562	6064
Number of windows:		2	4	4	4	4	4	6	6

Maximum Over-Frame Size

Height	Width up to:	TRADITIONAL DESIGN DOUBLE LEAF							
		1250	2286	2438	2500	2750	3000	3188	3500*
Up to 2050 4 Section	White	2312	4492	4641	4806	4972	5137	5302	5468
	Wood/Trend Trend+	2728	4945	5095	5261	5333	5592	5757	5922
	RAL	3033	5246	5399	5564	5730	5895	6061	6226
Up to 2204 4 Section	White	2406	4614	4766	4945	5124	5302	5481	5660
	Wood/Trend Trend+	2822	5068	5218	5399	5580	5761	5942	6123
	RAL	3088	5371	5523	5701	5879	6056	6234	6412
Up to 2320 4 Section Up to 2500 5 Section	White	2505	4744	4909	5140	5371	5602	5833	6064
	Wood/Trend Trend+	2921	5198	5364	5594	5823	6053	6283	6513
	RAL	3186	5502	5668	5897	6126	6355	6584	6812

Note: if there is an obstruction that prevents the full opening of a door leaf we can limit the travel of the door stay/s to prevent a clash - talk to the team!

Traditional & Toplight Windows
Traditional Doors are supplied with mock leaded-effect Polymer windows as standard, applied to the external face of the window only. Black or White mock leaded effect is available as an option. Polymer windows are available in clear, frosted or satin. Toplight polymer are supplied with mock leaded-effect Polymer windows as standard, applied to the external face of the window only. Black or White mock leaded effect is available as an option. Polymer windows are available in clear, frosted or satin. Each window unit is 370mm wide x 680mm high. Unleaded Polymer windows are available for both designs as a no-cost option - please specify your requirement when ordering.

Frames & Door Leaf Frames
Frames and door leaf frames in selected Trend colours & wood design are finished in a complementary flat colour: Golden Oak (RAL8003), Rosewood (RAL8016), Night Oak (RAL8014), Winchester (RAL8001), Ice Crystal Grey Aluminium (RAL9007) TT9016 Bling White (RAL9016). Frames and door leaf frames are available in smooth finish only (excluding textured anthracite). Prices are for a single colour to all components of the door. If you require a different colour for the frame to the door panel a surcharge will apply - please contact the office for details. As a guide, a different frame colour is charged at £150 for any size of door.

Door Restrictor
A door restrictor is available on door leaves below 810mm width down to minimum leaf width 500mm - see technical specification for more detail. Must be requested when ordering.
Open-Out / Open-In
Doors are supplied open-out as standard. Open-in is available as an option - please specify when ordering. NOTE: open-in doors increase the likelihood of water ingress. A drip guard is recommended on open-in doors

***Doors Over 3188mm**
Doors over 3188mm wide are supplied with surface mounted hinges (not concealed) and as a loose frame and door leaves for assembly on site.
Threshold
All* doors include a 3-part raised aluminium threshold for improved weather protection. *Doors over 3000mm wide are supplied with the 1-piece threshold.

Colours
Where doors are exposed to direct sunlight, dark colours should be avoided. RAL/BS references for colours are provided as a guide only to the nearest similar RAL/BS colour. Colours will not match to other RAL/BS finishes due to different coating processes, gloss levels, substrates and textures. Similarly, special RAL, BS, wood effects or other colours will not be a precise match. *RAL9006 and 9007 pose particular problems when colour matching, more information is available via the sales office. Colours shown are limited in accuracy by the printing process - samples should always be requested. If you are matching to other finishes, particularly wood effects such as Rosewood, Golden Oak, Night Oak or Winchester, always request a sample.

WINDOWS & OPTIONS

WINDOWS - POLYMER DOUBLE GLAZING Polymer casement with polymer (Styrene Acrylonitrile) double glazed unit.

Georgian

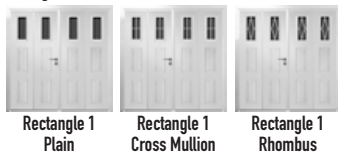

Standard Rib, Centre Rib & Solid

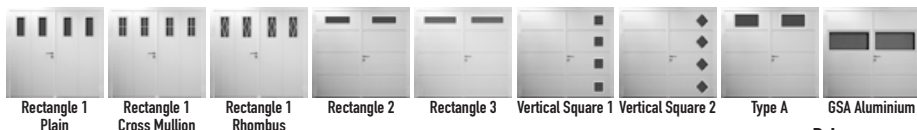

Style	Overall Size	Colour / Finish	Price per Window
Rectangle 1	610 X 270	White Trend/Trend+/Ral/Wood design	£155 each £203 each
Rectangle 2	680 X 210	White Trend/Trend+/Ral/Wood design	£155 each £203 each
Rectangle 3	980 X 140	White Trend/Trend+/Ral/Wood design	£186 each £243 each
Square 1 & 2	270 x 270	White Trend/Trend+/Ral/Wood design	£155 each £203 each
Type A	680 x 370	White/ Trend/Trend+/ Ral/Wood design	Without leading £271 each With leading £312 each
GSA Aluminium Window Section	per linear m	White/Trend Trend+/Ral/Wood design	POA POA

All polymer windows are available with these glazing options:

*The exterior pane is Frosted/Satin and the interior pane is Clear.



Polymer Windows

To price for windows fitted vertically down the door; square type 1 & 2, match windows to number of sections ie 4 sections = 4 windows).

Selected Trend colours & wood design windows are finished in a complementary flat colour for Golden Oak (RAL8003), Rosewood (RAL8016), Night Oak (RAL8014), Winchester (RAL 8001), Textured Anthracite (RAL7016), Ice Crystal Grey Aluminium (RAL9007) and TT9016 Bling White (RAL9016).

The surrounds on aluminium GSA window sections are finished in a smooth finish. Window frame colour shade and surface lustre will show a variance from the panel finish as the base material and coating methods are different.

OPTIONS (For general options & spares see back page).

Coastal paint upgrade Add to RAL price Frame, leaf capping and external face of panels. Must be combined with the 316 lever handle upgrade or the 3-Point Locking for doors with CarTeck Lever handles	£58 m ²
Paint internal face of door panels to match exterior colour add to RAL price NEW!	£150 m ²
Drip Guard Single Leaf Recommended on inward opening doors	£88
Drip Guard Double Leaf Recommended on inward opening doors	£173
Surface Mounted Hinges (In place of concealed hinges)	FOC
Pet flap fitting charge (Customer supplied)	£52
Letter box fitting charge (Customer supplied)	£52
Letter box Letter boxes and finger pulls are available finished in Satin Nickel as standard with an option for Gold, Rose Gold, Chrome, Black.	£130
Finger pull White or Anthracite.	£38
Spy hole	£52
Customer hardware fitting	POA

Coastal/high salinity environments

Doors installed in coastal/high salinity environments must have the coastal paint upgrade and be fitted with 316 stainless steel lever handle upgrades or 3-Point Locking for doors with CarTeck lever handles. Doors with standard stainless steel or black handles may experience corrosion of the handle and discolouration of the surrounding door finish, this is excluded from warranty claims.

HANDLE OPTIONS Stainless steel lever handles as standard

D-Handles 1200mm Stainless Steel** 38mm	£334 each
D-Handles 1500mm Stainless Steel** 38mm	£395 each
Black Powder Coated Lever Handle Supplied in place of Stainless Steel***	£69 pair
Lever Handle Upgrade 316 Stainless Steel	£47 pair

**For how to care for stainless steel see: www.teckentrup.co.uk/garage-doors/frequently-asked-questions-faqs#stainless_care

***Black powder coated handles may chip with use.

ALUMINIUM WINDOWS - POLYMER DOUBLE GLAZING Aluminium and polymer casement with polymer double glazed unit.

PRICE PER WINDOW

£382

PRICE PER SET

£914



Minimum over-frame height for Kappa windows used vertically on side hinged doors:

3 & 1 Part Threshold:
2050mm with stay
2010mm without door stay

4 Sided Frame:
2091mm with stay
2051mm without door stay

Satin Clear
All aluminium windows are available with these glazing options (satin is supplied as standard).

ALUNOX DECALS Factory bonded alunox decals. Decals can be positioned to requested positions, however, popular arrangements are shown here.

PRICE PER DECAL

£67

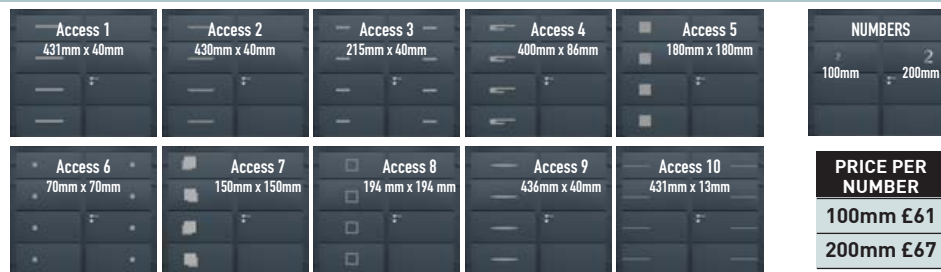

PRICE PER NUMBER

100mm £61
200mm £67

FIXED SIDE PANELS

Fixed side panels to reduce down the size of a large opening to allow a side hinged garage door to be fitted.

Panels match the door and include a full surround frame and fixings for attaching to the door frame or intermediate pillars (not supplied).

Up to 500mm x 2500mm £1000
Up to 1000mm x 2500mm £1250

To add windows use the per window price. Traditional & Toplight designs POA.



LOCKING OPTIONS Single point locking with stainless steel lever handles as standard

3-Point Locking for doors with CarTeck Lever handles

(Satin Nickel finish, active leaf) Minimum over frame height: 2000mm all doors. Suitable for high salinity environments

£245

Optional Handle finishes CarTeck 3-Point Locking Lever handles

Gold, Rose Gold, Chrome, Black, White, Anthracite. Suitable for high salinity environment

£58 pair

3-Point Locking for doors with Standard Stainless Steel Lever Handle, Black Powder Coated Lever Handle or D handles.

Minimum over frame height: 2020mm all doors

£553

Additional Key Each Standard/Security

£34/66

Keyed-alike per cylinder

£52

Code lock

£691

Smart Lock & Smart Lock Keypad for Bluetooth/Wifi* locking *Wifi requires a one-time online upgrade

NEW!

POA

Finger pull

£38

THRESHOLD OPTIONS 3-part raised aluminium as standard see page 13 for details

Aluminium Strip Threshold Profile (4mm)	-£50
1-Part Aluminium Raised Threshold Supplied as standard on doors over 3150mm wide	FOC
Four-Sided Frame 55mm Threshold	£125
Four-Sided Frame 40mm Full Overlap Threshold	£156

For door spares, motor spares & PVC finishing trims see back page.

TECHNICAL CARTECK SIDE HINGED GARAGE DOORS GSW 40-L

GEORGIAN DOORS

Horizontal doors have 2 columns of features as standard arranged 1/2 - 1/2, changing to an asymmetric three columns at the width shown below. 1/2 - 1/2 vertical doors have 2 rows of features as standard changing to three at the height shown right.

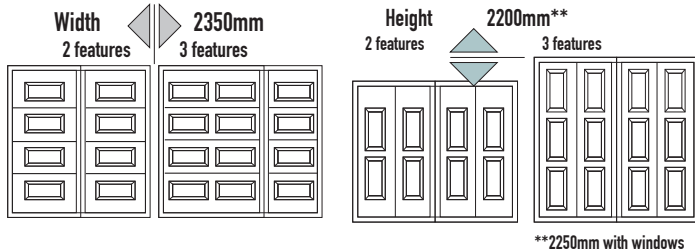

SPECIFICATION

DOOR:

Door leaves are fabricated using 40mm thick CarTeck panels with an extruded aluminium perimeter frame and integral seals. Doors with the optional standard threshold profile have an EPDM black threshold seal at the base. Each leaf is fitted with three concealed hinges. Large doors and doors with asymmetric leaves may have three or more hinges per leaf.

The door frame is an extruded aluminium profile with mitred corners and integral seals, for details refer to technical leaflet. A 3-part stepped aluminium threshold is also included. Doors over 3000mm wide are supplied with the 1-piece threshold. 10mm tolerance should be allowed to facilitate frame squaring during installation.

Doors supplied open-out as standard. Open-in is available as an option - please specify when ordering. NOTE: open-in doors increase the likelihood of water ingress. We recommend the drip guard option is selected with open-in doors.

HARDWARE:

Hardware comprises of a DIN standard CE marked European sashlock and a pair of stainless steel round bar lever handles on 50mm diameter roses. A Satin Nickel CarTeck lever handle is supplied with the 3-point hook locking option. A Euro-profile cylinder and thumb turn with stainless steel escutcheons is included as standard (double cylinder, key both sides is available as an option if required). Three keys are supplied with each cylinder. The inactive leaf is fitted with top and bottom recessed lever action flush bolts. A stay is fitted to each leaf to hold the door in the open position, any leaf below 810mm wide (including

asymmetric side hinged doors) will not have a stay. Foot stops are available as an option and are suitable for any door leaf width. A friction stay is available for door leaves below 810mm wide down to the minimum leaf width of 500mm. Stainless steel** needs regular cleaning or will stain, especially in areas of high salt content. Doors installed in coastal/high salinity environments must be fitted with a 316 Stainless Steel lever handle upgrade or 3-point locking with CarTeck lever handle. Doors with standard stainless steel or black handles may experience corrosion of the handle and discolouration of the surrounding door finish. This will be excluded from warranty claims.

CLOUR:

The door frame and window frame colour shade and surface lustre will show a variance from the panel finish as the base material and coating methods are different. Where differing materials and process are adopted, such as side hinged GSW 40L garage doors, there may be some colour matching variations. Differing light conditions may further reduce or highlight this effect. The colours RAL9006 and 9007 pose particular problems when colour matching, more information is available via the sales office.

RAL/BS references for colours are provided as a guide only to the nearest similar RAL/BS colour. Colours will not match to other RAL/BS finishes due to different coating processes, gloss levels, substrates and textures. Similarly, special RAL, BS or other colours will not be a precise match.

**For how to care for stainless steel see: www.teckentrup.co.uk/garage-doors/frequently-asked-questions-faqs

DIMENSIONS AND CLEARANCES

CLEARANCES

IMPORTANT

When doors are ordered as a structural opening size, Teckentrup UK will deduct 20mm from the width and 10mm from the height for coursing tolerance. If this is more tolerance than you wish, please state the over-frame dimension you require.



The section height and the height of the handle 'x' depend on the actual door height and construction of the door.

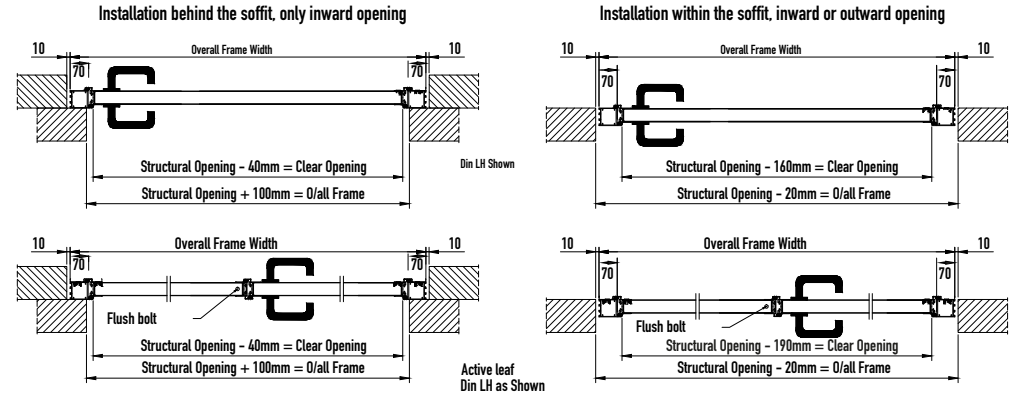

STANDARD 3-PART THRESHOLD

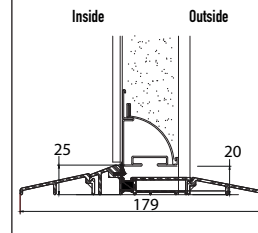

OPTIONAL 1-PART THRESHOLD

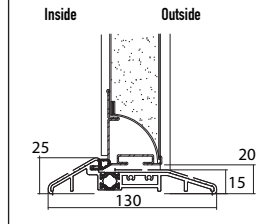

OPTIONAL ALUMINIUM STRIP THRESHOLD

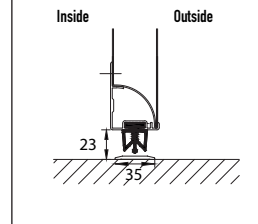

OPTIONAL FOUR-SIDED FRAME 55MM THRESHOLD

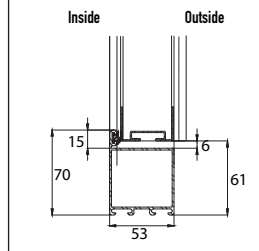

OPTIONAL FOUR-SIDED FRAME 40MM FULL OVERLAP THRESHOLD

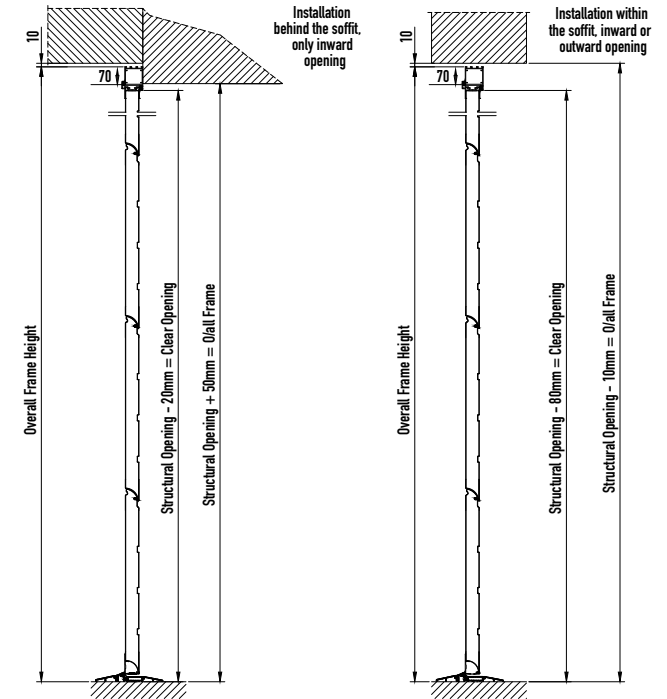
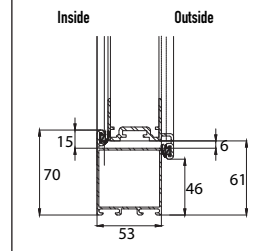

TECHNICAL CARTECK SECTIONAL GARAGE DOORS GSW 40-L & GSA/SLX VISION

DIMENSIONS ORDERING SIZES = DRIVE THROUGH SIZES

Observe the following measurement details to guarantee exact assembly and precise, reliable operation of CarTeck sectional garage doors.

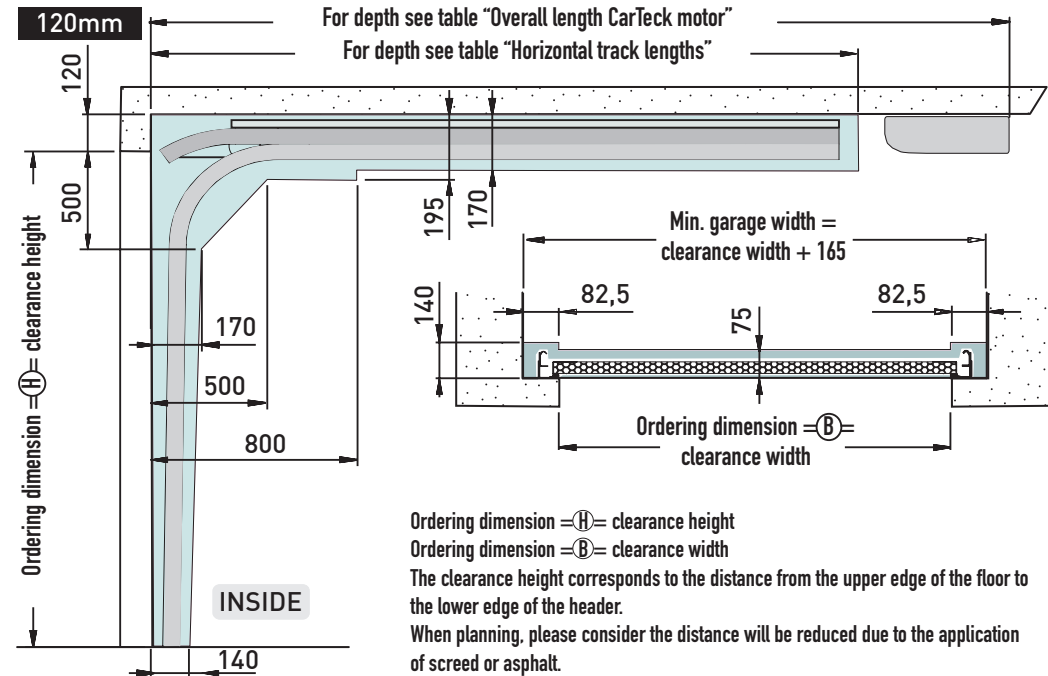

ORDERING NOTES:

Door heights achieved by mixing panel heights (except ribbed), use of 0, 9, 17, or 32mm bottom profiles or top & bottom panel cut downs.
When ordering use metric sizes, imperial conversions are nominal.

Frame holes & fixing brackets

Height	Width														Height						
	2084	2134	2235	2286	2388	2438	2591	2743	3048	3353	3658	3962	4216	4267		4420	4572	4877	5182	5500	
3000																					3000
2875																					2875
2750																					2750
2625																					2625
2500																					2500
2375																					2375
2250																					2250
2204																					2204
2175																					2175
2125																					2125
2084																					2084
2050																					2050
2000																					2000
1925																					1925
1875																					1875
Height	2084	2134	2235	2286	2388	2438	2591	2743	3048	3353	3658	3962	4216	4267	4420	4572	4877	5182	5500	Height	

Requires frame leg holes (standard frame) and twist fix frame leg brackets.

Twist fix frame leg brackets not required, but provided to assist with installation*.

No holes in frame leg as an option (between fix frame with stiffener brackets required).

Twist fix frame leg brackets required.

No holes in frame leg as an option (between fix frame with stiffener brackets required).

Standard frame leg hole position from edge of frame leg (seal side) to centre of fixing holes = 55mm.

*Doors below 70kg do not require twist fix brackets for strengthening, however they are included with all doors to assist with installation. They can be used outboard of the frame to locate a secure fixing when inbound fixing is not possible or sufficiently solid.

NOTE: 240mm headroom can affect these dimensions/specification - please consult the office when ordering. 2135mm high maximum for no holes frame with 240mm headroom kit.

RECOMMENDED HORIZONTAL TRACK FIXING POINTS

If the rear spacer bar extending side fixings are securely fixed, the second fixing point, shown within (O) is not required.

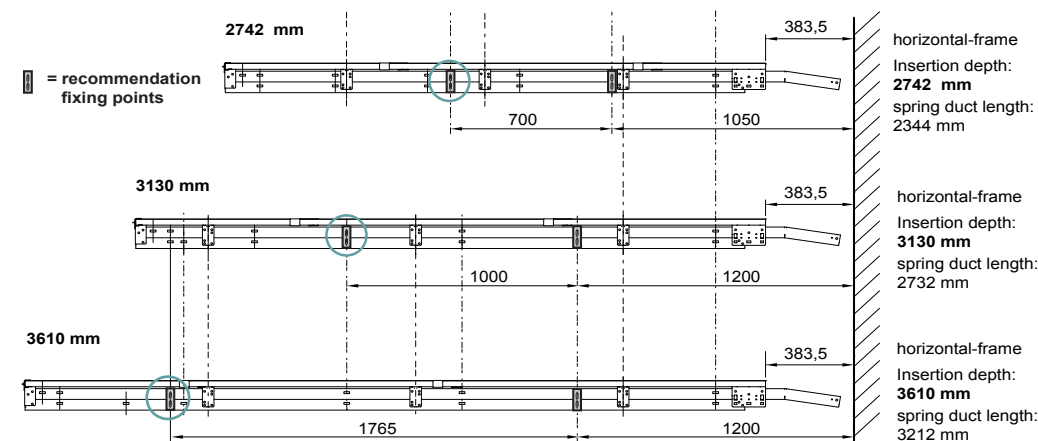

HORIZONTAL TRACK LENGTHS

Allow 115mm headroom. Use standard lifting gear. Allow 140mm headroom above trays only. Gear uses twin springing & commercial roller spindles

Height	Width														Height						
	2084	2134	2235	2286	2388	2438	2591	2743	3048	3353	3658	3962	4216	4267		4420	4572	4877	5182	5500	
3000																					3000
2875																					2875
2750																					2750
2625																					2625
2500																					2500
2375																					2375
2250																					2250
2204																					2204
2175																					2175
2125																					2125
2084																					2084
2050																					2050
2000																					2000
1925																					1925
1875																					1875
Height	2084	2134	2235	2286	2388	2438	2591	2743	3048	3353	3658	3962	4216	4267	4420	4572	4877	5182	5500	Height	

3610mm

3130mm

2742mm

Horizontal tracks can be reduced on request for £192. Speak to the CarTeck sales office for limitations.

NOTE: 240mm headroom can affect these dimensions/specification - please consult the office when ordering.

SPECIFICATION

GSW 40-L Sectional door

DOOR: Sectional door double skinned PUR foam core, 40mm thick CarTeck panels. Outer surface finished in choice of 4 standard designs and all standard listed CarTeck colours. Inner surface stucco design, colour similar to RAL 9002. Sections have a centre seal, EPDM, header, and floor seals. Different order heights are made up from mixing panel sizes, 4 different bottom profile sizes and reduced top panel heights.

FRAME: Door frame is made from galvanized sheet steel, coil coated with polyester, prime coated similar to RAL 9016 or other Trend colour. Protective strips with EPDM sealing lips on both sides of the vertical tracks.

HARDWARE: Galvanised finish, screwed hinges to all sections, adjustable rollers with ball bearings. Multiple tension springs and double cable system housed in low friction housing above horizontal tracks.

AUTOMATION: Door prepared for automation as standard with manual locking available as optional extra.

COLOURS

RAL/BS references for colours are provided as a guide only to the nearest similar RAL/BS colour. Colours will not match to other RAL/BS finishes due to different coating processes, gloss levels, substrates and textures. Similarly, special RAL, BS or other colours will not be a precise match.

The door panel, frames and window frame colour shade, and surface lustre will show some slight variation, this is due to different base materials and coating methods.

GSA / SLX Vision Sectional door

DOOR: Sectional door panels made from hollow aluminium profiles, 40mm depth filled with 16mm scratch resistant, polymer double glazing. Sections have a centre seal, EPDM, header, and floor seals. Door heights are achieved by equal division of panel heights ranging from 300mm to 750mm.

FRAME: Door frame is made from galvanized sheet steel, coil coated with polyester, prime coated similar to RAL 9016 or other Trend colour. Protective strips with EPDM sealing lips on both sides of the vertical tracks.

HARDWARE: Hardware, galvanised finish, screwed hinges to all sections, adjustable rollers with ball bearings. Multiple tension springs and double cable system housed in low friction housing above horizontal tracks.

AUTOMATION: Door prepared for automation as standard.

COLOURS

RAL references for colours are provided as a guide only to the nearest similar RAL colour. Colours will not match to other RAL finishes due to different coating processes, gloss levels, substrates and textures. Similarly, special RAL, BS or other colours will not be a precise match.

The door panel, frames and window frame colour shade, and surface lustre will show some slight variation, this is due to different base materials and coating methods.

NO HOLES FRAME FIXING



IMPORTANT !

When fixing a no-holes frame between the reveal you must secure the frame to the lintel as shown using the 'L' bracket supplied. If a good fixing cannot be achieved, alternative fixing methods must be used to secure the frame.

OPERATOR RAIL FOR CARTECK DRIVE & DRIVE PRO

		Width																			
Height		2084	2134	2235	2286	2388	2438	2591	2743	3048	3353	3658	3962	4216	4267	4420	4572	4877	5182	5500	Height
3000																					3000
2875																					2875
2750																					2750
2625																					2625
2500																					2500
2375																					2375
2250																					2250
2204																					2204
2175																					2175
2125																					2125
2084																					2084
2050																					2050
2000																					2000
1925																					1925
1875																					1875

Drive 4650mm Drive Pro 4423mm

Drive 3554mm Drive Pro 3327mm

CARTECK DRIVE 500 / 600 DIMENSIONS

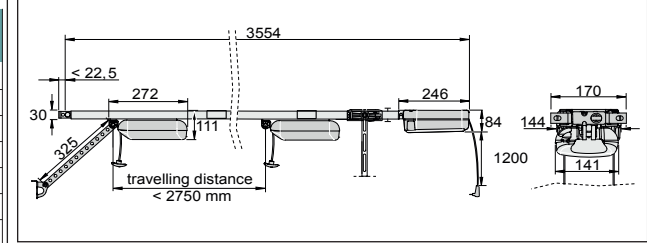

CARTECK DRIVE PRO 500 / 600 DIMENSIONS

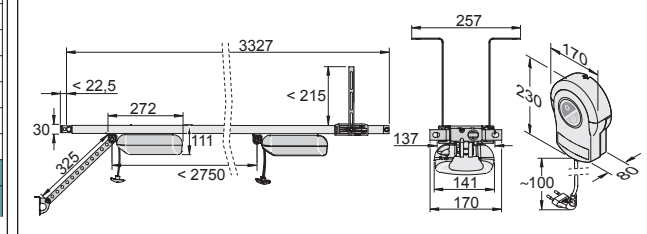

CARTECK MOTOR L60 AND L75 DIMENSIONS

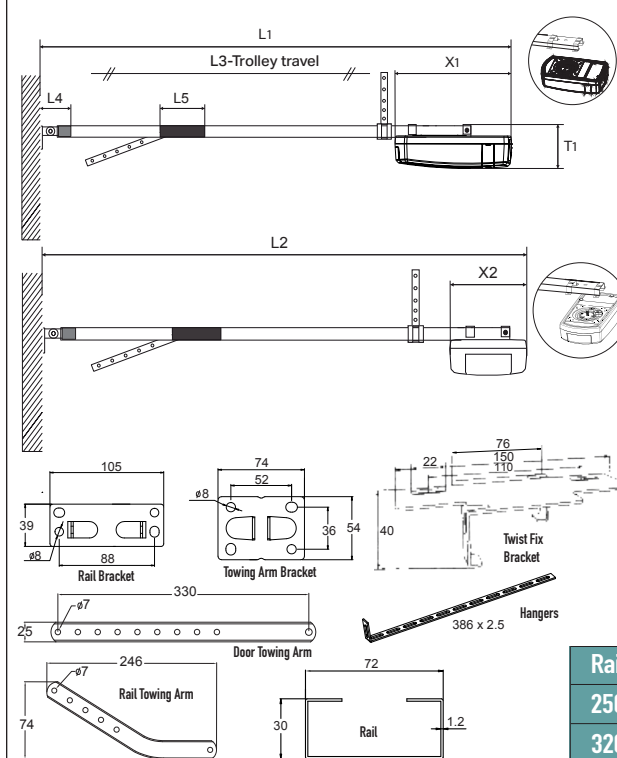

LIFTING RANGE & RAIL REQUIREMENT FOR CARTECK MOTOR L60 AND L75

		Width																			
Height		2084	2134	2235	2286	2388	2438	2591	2743	3048	3353	3658	3962	4216	4267	4420	4572	4877	5182	5500	Height
3000																					3000
2875																					2875
2750																					2750
2625																					2625
2500																					2500
2375																					2375
2250																					2250
2204																					2204
2175																					2175
2125																					2125
2084																					2084
2050																					2050
2000																					2000
1925																					1925
1875																					1875

>2500mm Rail Extension Required

<2500mm Standard Rail

Rail Clash
There is the potential for a clash between the motor head and the rear spacer bar on 3130mm track depth when using a standard length motor rail with restricted headroom. Contact the office for solutions, or use a rail extension.

Rail Details (mm)	Rail	L1	L2	L3	L4	L5	X1	X2
2500mm Door	3187	3372	3242	2687	180	165	380	142
3200mm Door	3980	4165	4035	3500	180	165	380	142

TECHNICAL CARTECK XL & SUPERSIZE SECTIONAL GARAGE DOORS GSW 40-L

XL DIMENSIONS AND CLEARANCES

120 mm lintel version

Clear passage height = ordering dimension height - 40 mm

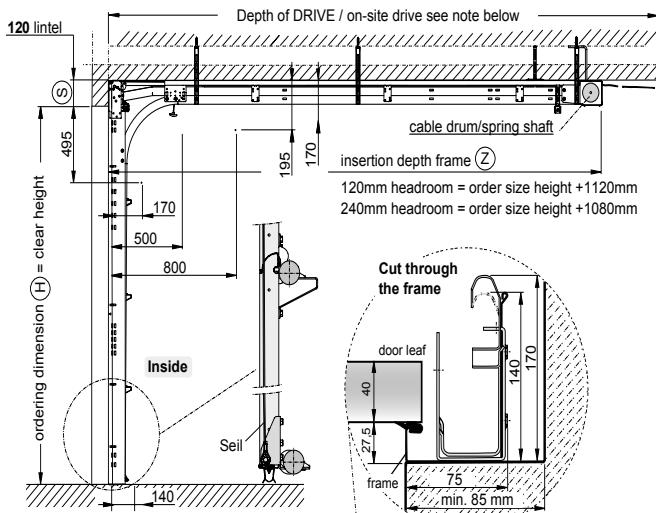

240 mm lintel version

Clear passage completely free

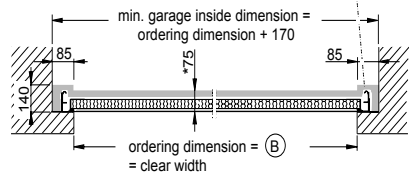
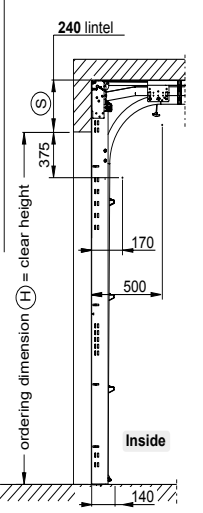

- (B) passage width (= ordering dimension)
- (H) clear height (=ordering dimension)
The clear height corresponds to the distance from the top edge of the finished floor to the lower edge of the lintel.
When planning, please also consider the reduction of the distance through the application of screed or asphalt.

SUPERSIZE DIMENSIONS AND CLEARANCES

N - Normal fitting

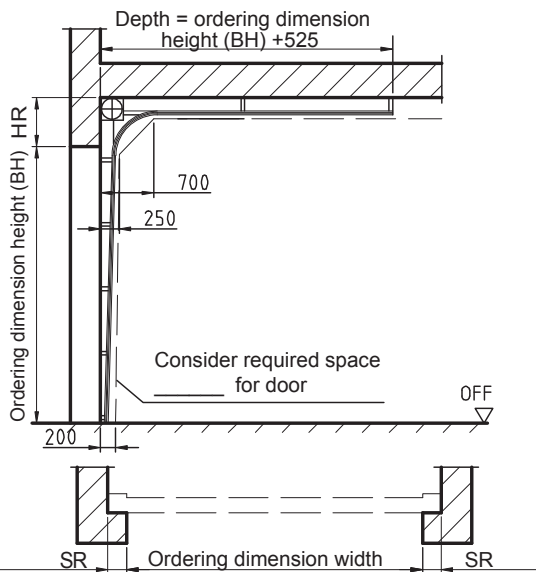

- SR= side room with rail motor = 110
- SR= side room non-drive side with direct drive motor = 110
- SR= side room drive side with direct drive motor = 210

NSH - Low headroom fitting

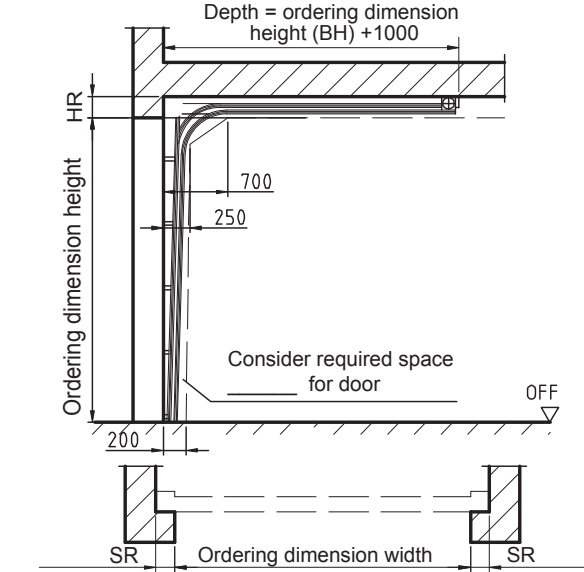

- SR= side room with rail motor = 120
- SR= side room non-drive side with direct drive motor = 120
- SR= side room drive side with direct drive motor = 210

XL SPECIFICATION

DOOR: Sectional door double skinned PUR foam core, 40mm thick CarTeck panels. Outer surface finished in choice of 4 standard designs and all standard listed CarTeck colours. Inner surface stucco design, colour similar to RAL 9002. Sections have a centre seal: EPDM, header, and floor seals. Different order heights are made up from mixing panel sizes, 4 different bottom profile sizes and reduced top panel heights.

FRAME: Door frame is made from galvanized sheet steel, coil coated with polyester, prime coated similar to RAL 9016 or other Trend colour. Protective strips with EPDM sealing lips on both sides of the vertical tracks.

HARDWARE: Galvanised finish, screwed hinges to all sections, adjustable rollers with ball bearings. Rear mounted torsion springs. 120mm headroom has clear opening height -40mm, 240mm headroom has full clear opening height.

AUTOMATION: CarTeck DRIVE Pro 1100 rail operator.

SUPERSIZE SPECIFICATION

DOOR: Sectional door double skinned PUR foam core, 40mm thick CarTeck panels. Outer surface finished in choice of 3 standard designs and all standard listed CarTeck Trend colours. Inner surface stucco design, colour similar to RAL 9002. Sections have a centre seal: EPDM, header, and floor seals. Different order heights are made up from mixing panel sizes, 2 different bottom profile sizes and reduced top panel heights. Doors have reinforcing steel profiles on the rear of the panels.

FRAME: Door frame is made from hot dipped galvanised steel sections. Protective strips with EPDM sealing lips on both sides of the vertical tracks.

HARDWARE: Doors have galvanised frame legs and are supplied without a header strip. Hardware has galvanised finish, screwed hinges to all sections, adjustable rollers with ball bearings. Front or optional rear mounted torsion spring with load-bearing steel cables. 1 pair of tension bars.

AUTOMATION: Electric 230V drive as standard, either direct or rail drive. Optical safety edge, hard wired to control system and photocells. Direct drive motor must have 13 amp supply direct to consumer unit. External release is not possible with direct drive motor, additional access must be available into garage.

SUPERSIZE HEADROOM REQUIREMENT (HR)

Heights		Widths						
			6000	6500	7000	7500	8000	
4 Sections	2280	Rail Operator	Stand Headroom	400	450	-	-	-
		Low Headroom	300	300	-	-	-	
	Direct Drive	Stand Headroom	400	450	450	450	450	
		Low Headroom	280	280	280	280	280	
5 Sections	2835	Direct Drive	Stand Headroom	400	450	450	450	450
			Low Headroom	280	280	280	280	280
6 Sections	3000	Direct Drive	Stand Headroom	400	450	450	450	450
			Low Headroom	280	280	280	280	280

Max Width For Low Headroom = 7750

300mm low headroom with rail operator is to prevent the top panel seal rubbing on the rail
If this is not an issue then the door will fit in 280mm

COLOURS

RAL/BS references for colours are provided as a guide only to the nearest similar RAL/BS colour. Colours will not match to other RAL/BS finishes due to different coating processes, gloss levels, substrates and textures. Similarly, special RAL, BS or other colours will not be a precise match.

The door panel, frames and window frame colour shade, and surface lustre will show some slight variation, this is due to different base materials and coating methods.

FITTERS TIPS SECTIONAL DOORS

FRAME TYPES, BETWEEN FIX, USEFUL OPTIONS AND FITTING INFORMATION



Which Frame type?



Standard Frame (with back fixing holes)

Use this frame for:

- **Back-fix**
- **Part-within fix**
show up to 48mm of frame leg within the opening
- **Between the reveal fix**
In conjunction with 3D profile covers

Between Fix Frame (without back fixing holes)

Use this frame for:

- **Between the reveal fix**
Up to a maximum size of 5500mm (18'0") wide and 2250mm (7'4") high

Does not require 3D cover profiles

Optional extra accessories to make between fix easy:



Kit Shown used with L shaped bracket



Bracket and fixings

Twist fix header kit When fitting between the reveal the frame header must be secured. The kit includes a pair of brackets that facilitate a solid fix for the header by providing a fixing point for "L" shaped brackets.

L Shaped brackets Our L shaped brackets are supplied in pairs and might be just the job for securing that header in conjunction with the twist fix header kit!

Between fix kit The kit includes brackets that allow a fixing to be made behind the frame leg and is suitable for both the standard frame and between fix frame. The kit also includes white grommets for filling exposed frame fixing holes if you are using a standard frame.

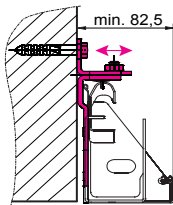

Between fix bracket shown from both sides on a no-hole frame leg.

Twist fix frame leg retaining brackets Twist fix brackets are supplied with every size door but are not required on doors up to 2743mm (9'0") wide and 2250mm (7'4") high and under 70kg (You just fix straight through the frame fixing points for a secure and solid frame installation). Doors over this size do require twist fix brackets, they add rigidity to stop frame deflection.

Although not required on some doors, all fixing packs include them to assist with installation. They can be used outboard of the frame to locate a secure fixing when inbound fixing is not possible or sufficiently solid.

Why twist fix? Simple – they just locate through the frame and twist into position ready for fixing through. No fiddly nut and bolt to secure each bracket, just a super quick twist, fix and done!



Twist fix brackets - no nuts!

Spacer Bar Suspension Plates This bracket is needed when fitting a CarTeck DRIVE motor and you need to keep the motor within 120mm headroom. It allows the spacer bar to be lowered by 20mm (page 8 for pricing)



Send tracks up to the ceiling

To order a door with tracks & spring trays that mount at ceiling level and that are above 240mm headroom, price the height for the opening + lintel height and advise the office when ordering.

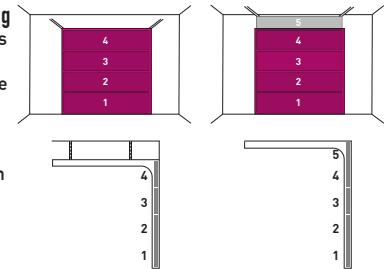

Header positioning options on the frame legs

The two groups of three fixing holes at the top of the frame leg allow the header to be fixed at different levels relative to the top of the frame leg.

0mm sits flush with the top of the frame leg – the standard position.

-10mm sits 10mm down from the top of the frame leg.

-20mm sits 20mm down from the top of the frame leg.

-10mm and -20mm allow you to show an amount of header below the lintel when back fixing. This is useful if you want to even up the appearance when frame legs are showing within the reveal.

You can also use these positions to drop the header if the door is sitting low in the tracks to ensure the top panel closes against the top seal without a gap.

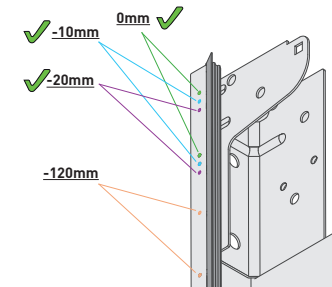

-120mm sits 120mm down from the top of the frame leg.

Use this position when fitting a 240mm headroom kit - it drops the header down 120mm to align with the top of the door panel.

240mm headroom kit This simple bracket lifts the tracks up an additional 120mm - great for getting over a gas meter or when a pass door comes into the garage – and it's free of charge. Just make sure you request it when ordering!



BETWEEN FIX

There are things you must do to ensure a sound installation on a no-holes frame: **YOU MUST USE THE LINTEL FIXING TO SECURE THE TOP OF THE FRAME LEG OF A NO HOLE FRAME***



Pre-fitted Lintel fixing brackets - **IMPORTANT!** These must be used to secure the top of the frame leg, preventing lateral movement. If you can't use the bracket you must find an alternative means to secure the frame leg.

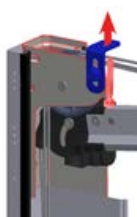

Stiffener brackets must be fitted to ensure the frame legs are prevented from twisting.

***Not required on standard frame between fix.**

FITTING TIP!

Before you fit the frame, fit the track curves to the legs, finger tight, so that when you position the frame between the reveal and access with a spanner is narrow, all the nuts will need is a nip to tighten!

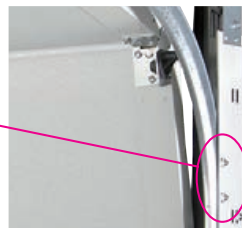

COLOUR TIP!

If you're fitting part within or fully within the reveal and you want your frame and header to match the door, don't forget to order a colour matched frame and header! See the notes on colour on the pricing pages to confirm which colours are available.

Fitting videos

Fitting your first door, need a refresher or just want to pick up a few tips - watch the full job or jump to a specific section, it's a great supplement to the paper fitting instructions.

Sectional Garage Door Fitting



3D profile kits These profile kits not only provide a neat solution for covering frame holes on standard frames but also allow gaps to be bridged and overlap onto the opening face to neaten up edges. The profiles are supplied in 3m lengths for on-site cutting to size. Doors >3m will require a butt joint on the header, for a seamless header choose the 850 or 120mm 3D frame leg kit and additional header.

The kits:

- 85mm frame leg kit** 2no. 85mm x 12mm x 3000mm
- 85/120mm 3D profile kit** 2no. 85mm x 12mm x 3000mm
1no. 120mm x 12mm x 3000mm
- 120mm 3D profile kit** 3no. 120mm x 12mm x 3000mm
- *85mm frame leg kit & additional door header 2no. 85mm x 12mm x 3000mm
(The additional door header will be supplied to the door ordering size +200mm)
- *120mm frame leg kit & additional door header 2no. 120mm x 12mm x 3000mm
(The additional door header will be supplied to the door ordering size +200mm)
- 70mm angle 3D kit 3no. 70mm x 12mm x 3000mm

* For doors over 3 metres wide – additional door header eliminates the join that would occur using a 120mm 3D profile (max length 3 metres)

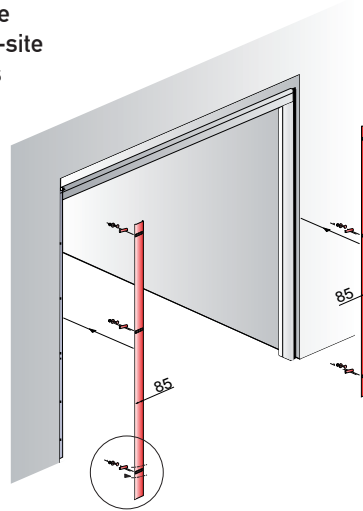

The 3D profiles have a smart fixing that allows for lateral movement – perfect for bridging small fitting gaps or tidying up the front face of the opening.

Shown here on the 85mm 3D profile.

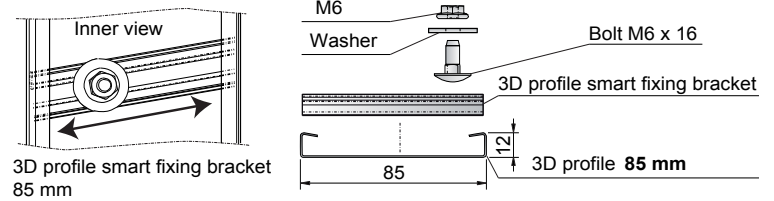

85mm frame leg 3D profile kit

85mm frame leg 3D cover profiles for between the reveal fit with lateral movement for up to 30mm gap coverage or up to 30mm overlap.

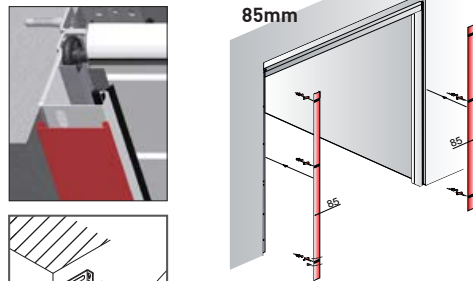

85mm/120mm 3D profile kit

Also available in a kit with a 120mm header 3D cover profile.

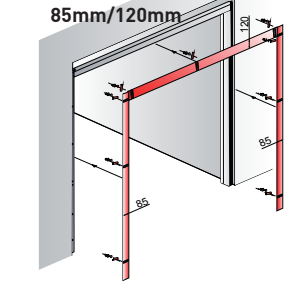

120mm 3D profile kit

120mm 3D cover profiles for between the reveal fit at the front edge with lateral movement for up to 65mm overlap.

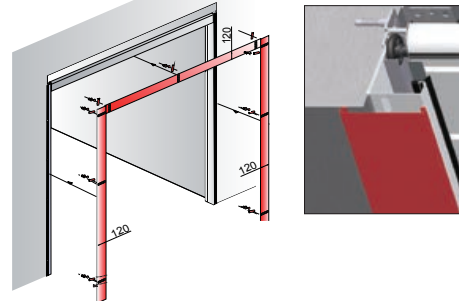

85/120mm 3D frame leg kit & additional door header

Perfect for doors over 3000mm wide – our 120mm 3D profile comes in 3000mm lengths requiring a butted joint on the header for larger doors – this kit includes a second full-width single piece header for a seamless finish. Choose kits with either 85mm or 120mm frame legs.

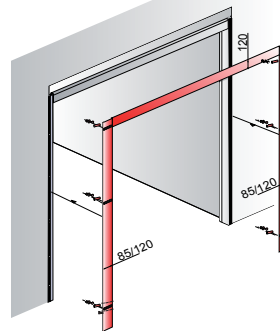

70mm angle 3D renovating profile

Use this when fitting behind the reveal or part between to neaten up damaged openings. The 70mm angle 3D renovating profile is held between the frame and the brickwork and will cover the back corner of the opening to tidy up any damaged wall edges. Ideal when removing timber frame and brick work deteriorated. Supplied in 3000mm lengths for on-site cutting to the required length.

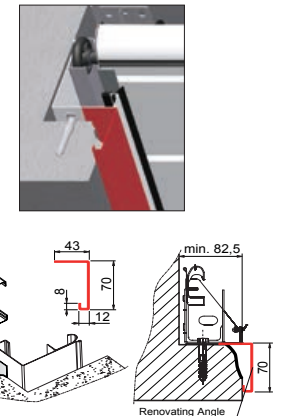

Note: The frame leg 3D kit profiles are 12mm deep and will create a step at the header. Use an 85/120 3D profile kit for a flush finish.

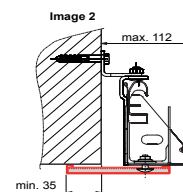
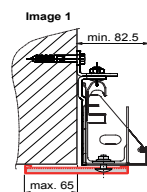
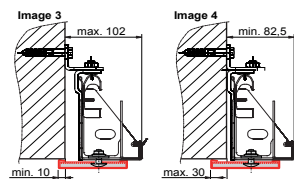
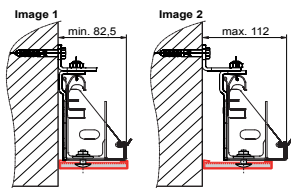

FITTERS TIPS SIDE HINGED DOORS

SIDE HINGED

Wind-out lugs to the side hinged frame for fast and easy frame setting

Position the frame in the opening, wind out the lugs with a 4mm allen key until the frame is true, level and square... ..and you're ready to fix.

No more fiddling with wedges or packers to get things set. Simple and fast frame setting! Up to 20mm of adjustment is possible on each side of the frame.



8 lugs per side

4mm allen key



2 lugs at each of the four fixing points per side.



Lugs are accessed through the frame fixing hole.

316 Stainless steel handles for coastal/high salinity locations

Doors installed in coastal/high salinity environments must be fitted with a 316 Stainless Steel lever handle upgrade. Doors with standard stainless steel or black handles may experience corrosion of the handle and discolouration of the surrounding door finish. This will be excluded from warranty claims.

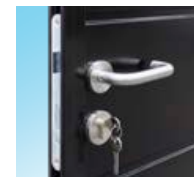

Concealed hinges

Doors are supplied with two or three concealed hinges per leaf, dependent on size. With no hinges at the edge of the frame, trimming up your opening is easy.

The concealed hinges are very easy to adjust, see for yourself:



CONCEALED HINGE ADJUSTMENT VIDEO - SCAN ME!

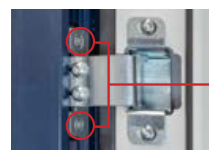

Vertical alignment

Use a T25 Torx to loosen these two screws to allow the leaf to move up and down in the frame profile, then tighten. All hinges will require adjustment.



Leaf-to-frame clearance

Use a T25 Torx to loosen these two screws, align using the slotted hole, then tighten. One or all may require adjustment.



Gasket clamping force

Use a T25 Torx to loosen these two screws, align using the slotted hole, then tighten. One or all may require adjustment.

IMPORTANT!! ALWAYS USE A TORQUE WRENCH SET TO 8.5NM TO TIGHTEN HINGE SCREWS

Trimming up

Concealed hinges make trimming up simple. If your trim overlaps onto the frame, ensure it is <10mm thick. Trim thicker than 10mm will foul the arc of the door leaf preventing full opening.

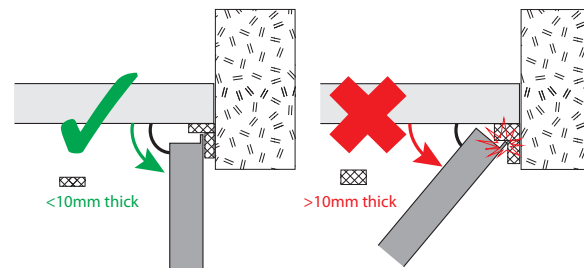

Fitting videos

Fitting your first door, need a refresher or just want to pick up a few tips - watch the full job or jump to a specific section, it's a great supplement to the paper fitting instructions.

Side Hinged Garage Door Fitting



DOOR SPARES

AUTOMATION SPARES

PVC PROFILES

DOOR SPARES		
SECTIONAL	PRICE	PER
Bottom rubber	30	m
Side seals 2655mm/3000mm	35	ea
Top seal	15	m
Bottom profile 0mm	35	m
Bottom profile 9mm	42	m
Bottom profile 17mm	49	m
Bottom profile 32mm	66	m
Top panel cut down profile	35	m
Bottom panel cut down profile	35	m
Panels use width of 4 section equivalent	20%	of total door price
Legs	264	ea
Horizontal Tracks	232	ea
Tray covers	81	ea
Spacer bars	35	m
Headers	42	m
Cables	81	pr
Springs	35	ea
Spring clips	13	ea
Rollers/pulleys/shreave wheels	19	ea
Spring tensioners (thread/nuts/hooks)	35	ea
Intermediate brackets	49	ea
Bottom brackets	49	ea
Centre hinges	18	ea
Top roller bracket including roller	49	ea
SIDE HINGED		
Raised threshold (including internal & external ramps)	145	m
Door stay (header bracket not included)	145	ea
Door stay header bracket white	14	ea
Door stay header bracket coloured	33	ea
Door stay grease pack of 20	14	ea
Stainless steel lever handle, rose and lock escutcheon	84	ea
3-point locking lever handle (specify colour)	89	ea
Concealed hinges	63	ea
Flush bolt	63	ea
Cylinder	47	ea
WINDOWS (Rectangle 1 & 2, Square 1 & 2)		
Window front white	66	ea
Window front painted	125	ea
Window glass (polymer)	66	ea
Window back	66	ea
Windows screws (14)	13	pk

AUTOMATION SPARES		
TECKENTRUP DRIVE	PRICE	PER
1. Door panel bracket standard	37	ea
2. Door panel bracket option E	37	ea
3. Door panel bracket option H	37	ea
4. Teckentrup hanger kit	49	ea
5. 90° hanger Kit	33	ea
6. Dexion Blocks	15	ea

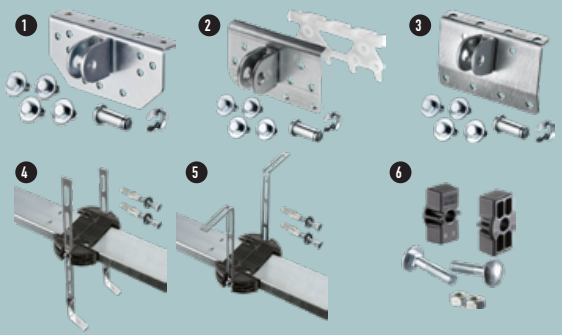

TECKENTRUP MOTOR	PRICE	PER
1. Straight door arm 230mm long	39	ea
2. Curved door arm 45°	39	ea
3. Curved door arm 90°	39	ea
4. Stepped door arm	64	ea
5. Long door arm	64	ea
6. Hanging strap tooled up	45	ea
7. Operator hanging bracket	46	ea
8. Twist fix bracket	43	ea
9. Sliding bracket	41	ea

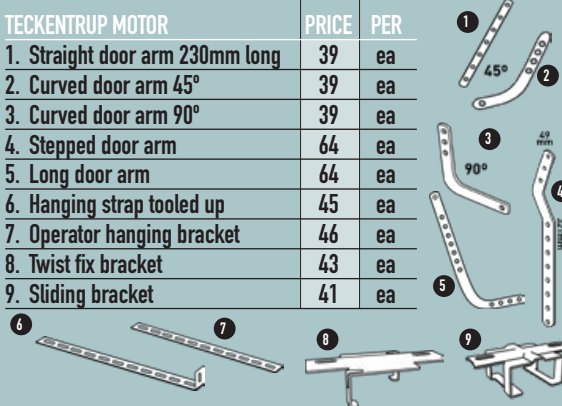

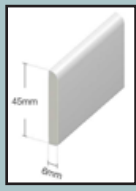
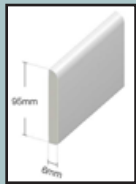
PVC PROFILES	
IMPORTANT:	
<ul style="list-style-type: none"> PVC Profiles are only available in white, TREND+, TREND Satin and RAL colours (Trend colours are not available). Profiles must be ordered with a door and must be the same colour as the door. Profiles are supplied in 5m lengths only for on site cutdown. Profiles are supplied in a polymer sleeve. 	
	45mm x 5m length £58 ea
	95mm x 5m length £72 ea

Teckentrup UK Limited,
Units 2-4 Opus 9 Industrial Estate,
Woburn Road, Winwick Quay Warrington WA2 8UE

www.teckentrup.co.uk

t: 01925 924 050

f: 08701 314 843

e: sales@teckentrup.co.uk

TECKENTRUP
DOOR SOLUTIONS



Raising Standards
Safety Assured



Accredited Contractor
CHAS.co.uk



NBS Source



LPCB
124-125 Warrington
Warrington WA2 8UE



LPCB
Red Book



Constructionline
Platinum Member